

**INSTALLATION INSTRUCTIONS
USER GUIDE**

FabricSmart™ clothes washer

WA1068P model

NZ AU

Fisher & Paykel



CONTENTS

Introduction	3
Safety and warnings	4
Installation instructions	5
Before you do your first wash	11
Getting started quickly	12
FabricSmart™ controls	14
FabricSmart™ safety features	15
Eco-Active™ wash	16
Sorting	17
Loading	18
Detergent	19
Fabric softener	20
Wash cycles	21
Wash options	22
Customising wash cycles	27
Changing pre-set options	28
Caring for your washer	33
Before you call for service	35
Fault codes	37
Troubleshooting	38
Manufacturer's Warranty	42
Customer Care	44

IMPORTANT!

SAVE THESE INSTRUCTIONS

The models shown in this user guide may not be available in all markets and are subject to change at any time. For current details about model and specification availability in your country, please go to our website www.fisherpaykel.com or contact your local Fisher & Paykel dealer.

Registration

Register your product with us so we can provide you with the best service possible.

To register your product visit our website: www.fisherpaykel.com



INTRODUCTION

Welcome to FabricSmart™

Thank you for buying a Fisher & Paykel FabricSmart™ clothes washer. We are proud of this washer and trust it will serve you well for many years.

At Fisher & Paykel we aim to provide innovative products that are simple to use, ergonomic and kind to the environment. Thousands of tonnes of washing and over 75 years of laundry experience have been programmed into your clothes washer to help give you the best possible performance.

Your FabricSmart™ washer has an extra large capacity, and numerous wash cycles and options so you can perform every wash task with ease and spend less time in the laundry. With the ability to select the most efficient water level for each load, your FabricSmart™ washer makes it kinder on your wallet and the environment.

Please take the time to read these instructions carefully before you begin using your washer. Following the advice in this user guide will ensure you get the performance you expect from your machine and that you get the best possible wash results.

We hope you enjoy your new washer. We have certainly enjoyed designing it for you.

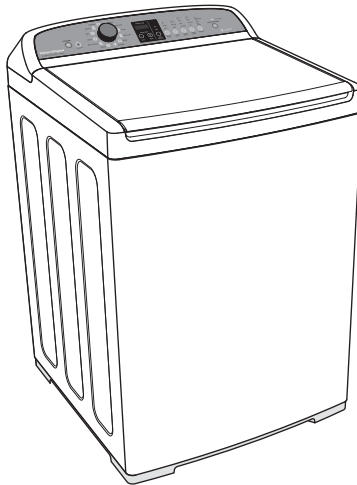

SAFETY AND WARNINGS



WARNING!



Electric Shock Hazard

If you are using an extension cord or a portable electrical outlet device (eg multi-socket outlet box), ensure that it is positioned so that it does not come into contact with water or moisture.

Failure to do so may result in death or electrical shock.

IMPORTANT SAFETY INSTRUCTIONS

WARNING! When using this appliance always exercise basic safety precautions including the following:

- This clothes washer is not intended for use by persons (including children) with reduced physical, sensory, or mental capabilities, or lack of experience and knowledge, unless they are supervised or given instructions on how to use the clothes washer by someone responsible for their safety, and they understand the hazards involved.
- The clothes washer should only be used for washing and rinsing of textiles where this is indicated on the care label.
- Keep children away from the clothes washer while it is in operation.
- Children should be supervised to ensure that they do not play with the appliance.
- Cleaning and user maintenance shall not be completed by children without supervision.
- The only user removable parts of the clothes washer are the inlet hoses and agitator. No other parts are designed to be removed by anyone other than a Fisher & Paykel Authorised Repairer.
- The lid will be locked for stages of the cycle for safety reasons.
- Never force open the lid.
- When disposing of the clothes washer, it is recommended that the lid is taped down to avoid children getting trapped inside, and that the electrical cable is cut off close to the clothes washer.
- Do not add gasoline, dry-cleaning solvents, or other flammable or explosive substances to the wash water. These substances give off vapours that could ignite or explode.
- Do not wash articles that have been previously cleaned in, washed in, soaked in, or spotted with gasoline, dry-cleaning solvents, or other flammable or explosive substances as they give off vapours that could ignite or explode.

INSTALLATION INSTRUCTIONS

Product and minimum clearance dimensions

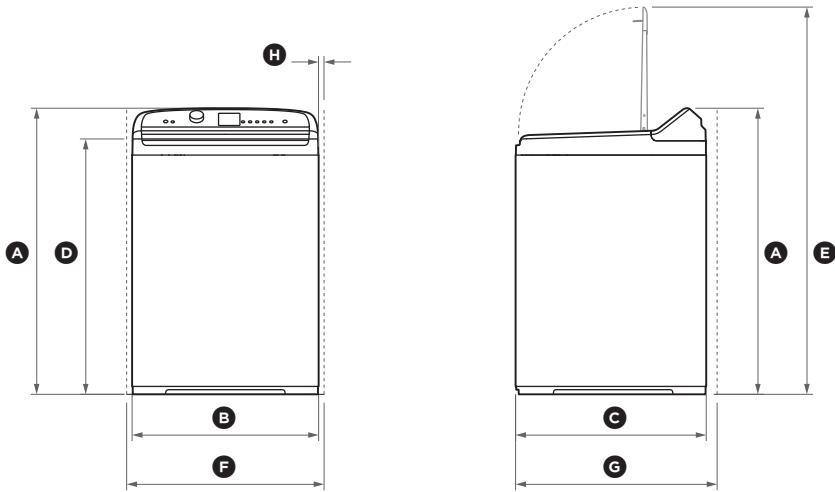

		WA1068P
PRODUCT DIMENSIONS		mm
Ⓐ	Overall height of product* (to highest point on console)	1060 - 1090
Ⓑ	Overall width of product	685
Ⓒ	Overall depth of product	700
Ⓓ	Height of product to top of lid* (closed)	950 - 980
Ⓔ	Height of lid open* (measured from bottom of product)	1440 - 1470
	Standpipe height	min 850 - 2400
MINIMUM CLEARANCES		mm
Ⓕ	Minimum cavity width	725
Ⓖ	Minimum depth clearance (including inlet hoses and drain hose)	750
Ⓗ	Minimum clearance to adjacent product# (dryer)	20
MAXIMUM CAPACITY		kg
		10.0

* Includes adjustable mounted feet and the range of movement.

Applies either side.

- Electrical supply: 220 V - 240 V, 50 Hz Sinusoidal, 10 A
- Inlet water static pressure: Max. 1 MPa (150 psi), Min. 34 KPa (5 psi)
- Inlet water flow rate at tap: Min. 6 litres/min
- Standpipe height: 850 - 2400 mm

INSTALLATION INSTRUCTIONS

Unpacking

To ensure the best performance from your new washer please follow the instructions below.

Removing the packaging

- ① Remove the outer packaging.
- ② Tilt the machine backwards and walk it off the base packer one foot at a time (ensure the lid is still taped down).
- ③ Remove the base packer from under the machine by tilting the machine backwards and pulling the packer out the front.
- ④ Remove the tape, lift the lid and remove the bowl packer from the bowl.
- ⑤ Remove the hoses and accessories.
- ⑥ Keep the base packer and bowl packer in case they are required for future transit.

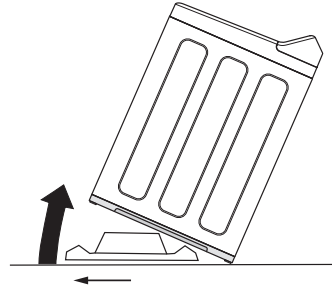

Tilt washer backwards to remove packer

IMPORTANT!

Please ensure that the base packer has been removed BEFORE OPERATING your machine.

Location

Your washer must be installed on a level surface and not on any textured floor coverings (eg carpet, rugs) to ensure that the opening at the bottom of the machine is not obstructed.

In your clothes washer you will find:

- 1 hose guide.
- 2 inlet hoses.

Drain hose

- ① Carefully pull the drain hose out from the back of the machine by pulling the exposed part of the hose downward and outward.
- ② To guide the drain hose over the tub or standpipe the hose guide MUST be fitted to the drain hose.

IMPORTANT!

To prevent siphoning the drain hose should not extend more than 20 mm from the end of the guide. The height of the standpipe or tub should be between 850 - 2400 mm. The drain hose can be trimmed to length.

- ③ Place the drain hose in the tub or standpipe. Do not fit the hose to a drain spigot. Drainage must not be airtight in order to prevent siphoning.

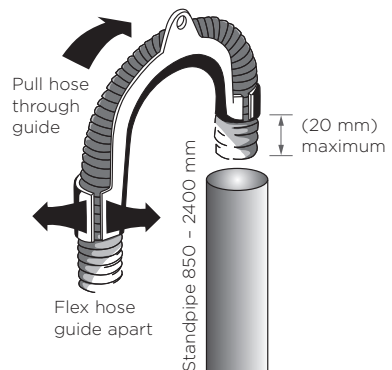

Fitting the drain hose guide

INSTALLATION INSTRUCTIONS

Electrical

This appliance must be supplied with a 220 - 240 V, 50 Hz, sinusoidal, 10 A electrical supply.

Draining

- Regularly check that your standpipe or tub is free from lint or other obstructions, which may affect how your machine works or may cause flooding.
- In multi-storey apartments or any upper floor, the machine should be installed on a floor equipped with a drain.
- Draining must comply with local by-laws.

Water supply

- Your cold water should not exceed 35°C and your hot water should not exceed 65°C. Temperatures above these may cause the machine to fault or cause damage to the machine.
- If you have an uncontrolled water heating source (eg a wet back or solar heating system) you should fit a Safe Valve. This will ensure the hot water temperature remains within safe limits.
- Inlet water static pressure: Max.1 MPa (150 psi) Min. 34 KPa (5 psi)
- Inlet water flow rate at tap: Min. 6 litres/min

HOT 'N' SAFE VALVES AVAILABLE ARE:

RMC TVA 50HF

RMC TVA 75HFS

Adjustable between 35°C - 55°C

RMC TVA 50HP

For instantaneous gas hot water supply

INSTALLATION INSTRUCTIONS

Inlet hoses

IMPORTANT!

- **New hose sets provided with the washer shall be used to connect the washer to the water mains.**
- **Old hose sets should not be re-used.**

- ① Connect the straight ends of the inlet hoses to the taps (there are washers fitted in both ends). Connect the red connector hose to Hot, and the white connector hose to Cold.
- ② Connect the elbow ends of the inlet hoses to the corresponding machine inlet valves. Inlet valves are marked on the back of the machine. Ensure the Hot valve is connected to the hot tap and the Cold valve is connected to the cold tap.

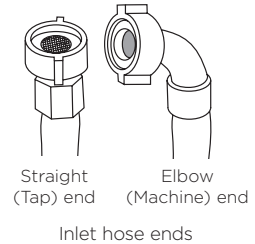

H = Hot C = Cold

Cold supply only:

If you only have a cold water supply, an inlet valve cap (blanking cap) **MUST** be connected to the Hot inlet valve. The cap prevents water leaking out of the hot valve. The cap is available from your Fisher & Paykel dealer or Authorised Repairer, Part No. 388491P. This appliance incorporates backflow protection complying with AS3500.1. No further backflow protection is required for connection to the water supply. Note: your washer does not have an internal heater to heat water.

Inlet hose replacement

We recommend replacing the inlet hoses every 5 years. Hoses should be checked from time to time and replaced if any wear, cuts, bulges, kinks or leaks are found.

WARNING!

Failure to do so may result in a flood and damage to property.

INSTALLATION INSTRUCTIONS

Levelling instructions

It is **IMPORTANT** to level the machine to ensure good spin performance and effective detergent and fabric softener dispensing.

A spirit level is provided with your machine. Use this to level your machine, always placing it on a clean, flat surface. The machine is level when the bubble sits in the centre, within the two lines.

Your washer is equipped with self-locking feet to ensure they do not move once you have levelled your machine. To adjust the feet, pull down then twist to move them up or down.

Note: after levelling, the corners of the washer should be clear of the floor and the machine must not rock in any direction.

- 1 Move the machine to its final position using the top corners to manoeuvre the product into place (do not push on the centre front of the machine). We recommend a minimum clearance of 20 mm each side and 50 mm at the rear of the machine.
- 2 With the lid closed, place the spirit level at the centre back of the lid (near the control panel). Pull the machine out and adjust the rear feet (wind down) until the machine is level side to side when in position.
- 3 Open the lid. Place spirit level on the flat surface on the left side, inline with the centre of the bowl. Adjust the front left foot (wind down) until the machine is level.
- 4 Move the spirit level to the right side, in line with the centre of the bowl. Adjust the front right foot (wind down) until the machine is level, and does not rock. There should be equal weight on both front feet so that neither can be turned by hand when the machine is in position.
- 5 Place the spirit level at the centre front of the topdeck, forward of the lid lock slot. Check the machine is level. Move the spirit level around to all positions once more, checking the machine is level in all areas. Check the machine does not rock side to side, front to back, or corner to corner.

IMPORTANT!

- **Keep your spirit level for the next time you move or reposition your washer.**
- **If moving or transporting your washer in the future, ensure you tape the lid down beforehand.**

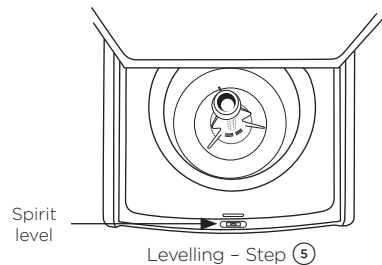
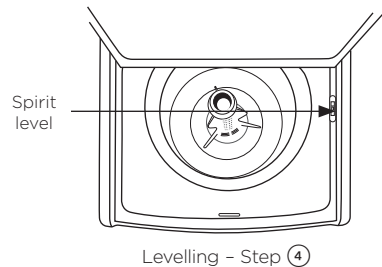
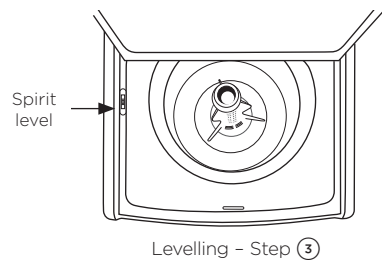
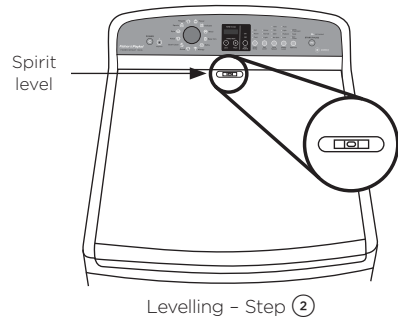

INSTALLATION INSTRUCTIONS

Completing your installation

- Turn on the water and check all hose connections for leaks. Make sure there are no kinks in the hoses. Check the hose connections for leaks again after 24 hours.
- Uncoil power cord, remove and discard the plastic pin cover, and plug into wall socket.

Installation test cycle

Your washer must be correctly installed before use. Check the installation and operation of the machine using the following procedure:

- ① Touch **I** to activate your washer.
- ② Touch both the **🔒** and 'Options' buttons at the same time, and hold for three seconds.
- ③ Touch **▶||** to start the installation test cycle.
- ④ The machine will beep to signal the end of the installation test cycle. Any faults will be displayed on the screen (refer to the back of this user guide to help identify faults). If you need further assistance, please contact a Fisher & Paykel Customer Care Representative. Refer to page 44 for contact details.

Note: if there are no faults found, the washer will automatically turn off at the end of the installation test cycle.

ACCESSORIES AND SPARE PARTS

Available from your Fisher & Paykel dealer or a Fisher & Paykel Authorised Repairer.

Inlet Valve Cap	Part No. 388491P
Hose Inlet Long (2 m)	Part No. 422680P
Hose Inlet Large Bore	Part No. 426123P
Drain Hose Extension	Part No. 425627P
Power Cord	If the power cord of your clothes washer is damaged it must be replaced by a Fisher & Paykel Authorised Repairer in order to avoid a hazard, as it is not a standard power cord.

BEFORE YOU DO YOUR FIRST WASH

You owe it to yourself and your washer to have your machine installed correctly.

Before you start, it is a good idea to go through the following checklist:

- ① Has the base space packer been removed? Refer to page 6.
- ② Is the drain hose threaded through the 'U bend' (with no more than 20 mm extended) and hooked into your tub or standpipe? Refer to page 6.
- ③ Is the hot hose connected to the Hot valve marked 'H'? Is the cold hose connected to the Cold valve marked 'C'? Refer to page 8.
- ④ Is the machine correctly levelled, feet are extended and cabinet corners are clear of the floor? Refer to page 9.
- ⑤ Have you performed the installation test cycle? Refer to page 10.

FabricSmart™ capacity

FabricSmart™ offers a very generous 10 kg capacity. The list below outlines what is included in a 10 kg wash load (in accordance with AS/NZS 2040.1:2005).

10 kg LOAD	
4 Sheets (double)	6 Pillowcases
8 Bath towels	6 Shorts
3 Tablecloths	4 Wash cloths
4 Shirts	2 Handkerchiefs
6 T-shirts	

Note: the above load composition is indicative only. We recommend for everyday use that you separate out your sheets and towels and wash them separately on the 'Regular' cycle.

GETTING STARTED QUICKLY

Before you start

- It is important to sort your clothes, particularly separating white/light colours from dark colours, as well as separating out sheets and towels. Refer to the 'Sorting and loading' section.
- Wash new, highly coloured and dark coloured items separately to prevent dye transfer onto other items.
- Sort lint givers and lint collectors (refer to the 'Sorting' section).
- Close bra clasps, do up zippers and check pockets.
- Place your clothes directly into the wash bowl.
- Place the load evenly around the agitator (refer to 'Sorting' and 'Loading' sections).
- Remove fabric softener dispenser cup.

Detergent

- Follow the manufacturer's instructions on the detergent package.
- Use the mark on the agitator, nearest to the top of the clothes, as a guide to the correct amount of detergent to use (refer to the 'Detergent' section).
- Pour the detergent down the centre of the agitator stem.
- Replace the fabric softener dispenser cup (this stops small articles falling down the centre of the agitator when you load the machine).

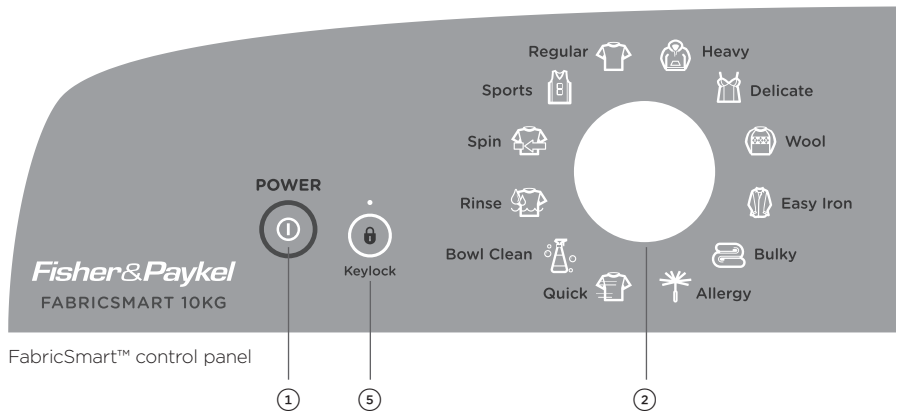
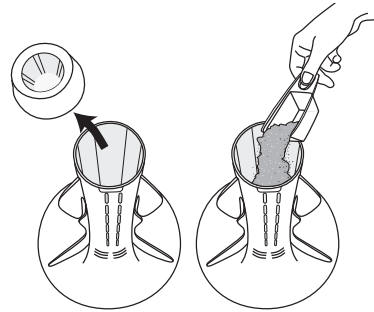

Fabric softener

If you wish to use fabric softener, place it in the fabric softener dispenser cup on the top of the agitator (refer to the 'Fabric Softener' section).

IMPORTANT!

Fabric softener must not be used if you have selected the 'Quick' cycle or the 'Eco Rinse' option (refer to the 'Fabric softener' section).

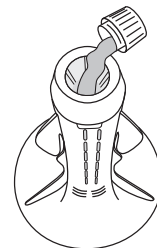

GETTING STARTED QUICKLY

Using your washer

The buttons require only a gentle touch to activate.

- ① Touch **I** to activate your FabricSmart™ washer.
- ② Select your desired wash cycle by turning the SmartTouch™ Control Dial. The wash cycle icons will illuminate as you turn the dial showing which cycle is selected (refer to the 'Wash cycles' section).
- ③ Choose your wash options, eg you may want a 'Warm' wash temperature and a 'Slow' spin speed (refer to the 'Wash options' section).
- ④ Touch **▶||** to start the cycle. The washer will start to fill with water and select the correct wash action for your load.

For best fabric and colour care, remove your clothes as soon as the cycle has finished.

- ⑤ Use 'Keylock' mode to lock the buttons on the display, which prevents them from being activated accidentally by a washing basket or little fingers (refer to the 'FabricSmart™ controls' section).
- ⑥ 'Delay Start' allows you to delay the start of your wash by 5 mins up to 18 hours (refer to the 'Wash options' section).

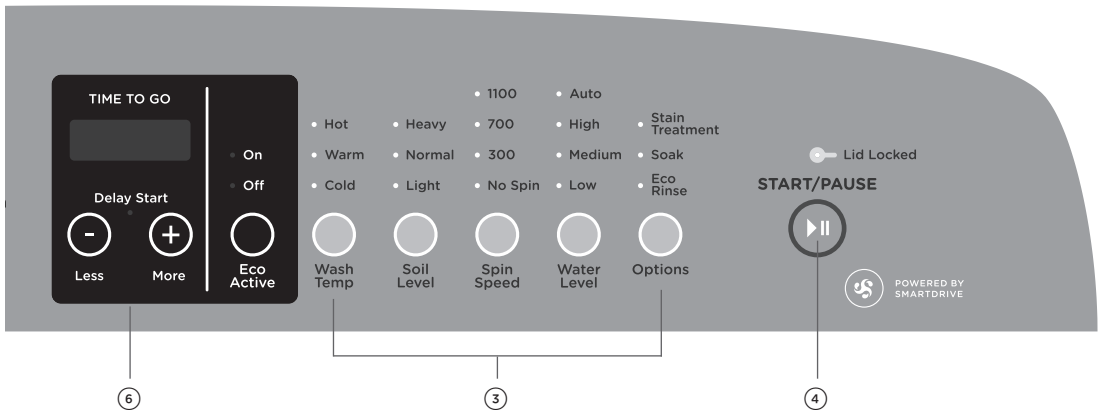

If you wish to stop your FabricSmart™ washer

- Press **▶||**.

During a spray rinse or spin, there will be a slight delay while the bowl slows to a stop and the lid is unlocked.

IMPORTANT!

Failure to follow the advice in this guide may result in damage to your garments, and your expectations of wash performance may not be met.

FABRICSMART™ CONTROLS

SmartTouch™ Control Dial

The SmartTouch™ Control Dial provides easy and efficient cycle selection. As you rotate the dial, the cycle selected will be illuminated, along with the default settings for that cycle on the right of the control panel.

SmartTouch™ buttons

The smooth, easy clean buttons require only a gentle touch to activate. Use these to power your machine on and off, start and pause your washer, select your wash options, activate keylock and programme a delay start.

Digital display screen

The digital display screen provides feedback on how long the wash cycle has to go, to keep you informed throughout the cycle. The screen also displays your 'Delay Start' selection, should you choose one. The delayed time remaining will show on the screen until the machine starts. The screen will also display messages to help you with the overall running of your machine.

Time to go

Your FabricSmart™ washer will display how many minutes a wash cycle has remaining, so that you can tell at a glance when your washing will be finished. Once you have selected your wash cycle and options, the time the wash cycle will take to complete will be displayed. Please be aware that actual cycle times may vary as they are influenced by a number of factors, eg the flow rate of your water supply, the load size and cycle selection.

Keylock mode





Keylock can be used to lock the buttons on your FabricSmart™ when not in use. This will avoid accidental button pushes from items left on the lid of the washer and also from any little fingers.

To turn 'Keylock' mode ON or OFF:

- Touch and hold the  button for 2 seconds.

Note: when activated, the light above the  button is illuminated.

If 'Keylock' mode is activated:

- To turn your washer on, **touch and hold the  button for 2 seconds.** This will activate the control panel. 'Keylock' mode will remain activated.
- To **pause** your washer at any time during the cycle, **touch and hold the  button for 2 seconds, or touch the  button twice in quick succession.**
- To **stop** your washer or power off at any time, **touch and hold the  button for 2 seconds or touch the  button twice in quick succession.**

FABRICSMART™ SAFETY FEATURES

Lid lock

The lid of your FabricSmart™ washer is locked for some parts of the wash cycle, ensuring safety for you and your family while it is operating.

The 'Lid locked' light (above the ►|| button) is illuminated when the lid lock is activated, letting you know at a glance if you can open the lid or not.

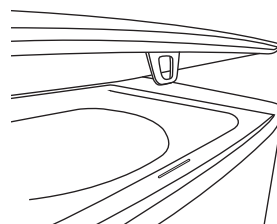

Lid lock

To unlock the lid at any time during the cycle press ►|| .

If the lid is left open, your FabricSmart™ washer will be unable to lock the lid, and the cycle will be halted. The machine will beep to alert you and display a warning message on the screen. If this occurs, close the lid and touch ►|| .

Note: the lid will be locked from the start of the 'Bowl Clean' cycle, through to the end, unless ►|| is touched.

IMPORTANT!

- **Do not put anything down the lid lock slot in the top deck of your machine.**
- **Do not try to disable the lid lock.**

Ensure that children or infirmed persons are well supervised when around your FabricSmart™ washer.

Auto drain

- Unsupervised clothes washers filled with water can present a drowning hazard to small children. In order to minimise any risk of this type of accident, your FabricSmart™ has been pre-programmed to know when this potential hazard is created and drains the wash water to a safe level.
- If you pause your FabricSmart™ at any time during the wash cycle when there is water in the bowl, the machine will activate the auto drain function after 3 minutes. This will drain the water in the wash bowl to an acceptable level, minimising any potential hazard.
- A warning message *A d r* will be displayed on the digital display while auto drain is in operation. The cycle can be restarted at anytime by touching ►|| .

ECO-ACTIVE™ WASH

Your FabricSmart™ uses a dual-action wash to give excellent wash performance while taking great care of your clothes. We call this the Eco-Active™ wash. The two parts to the Eco-Active™ wash are explained below:

Wash 1 - Detergent activating wash (front-loader type wash)

For both 'Eco-Active™, On' and 'Eco-Active™, Off' selections your FabricSmart™ washer fills the bowl at the selected temperature with just enough water so that your clothes are 100% saturated. This small amount of water flows down through the clothes, into the bowl base, mixes with the detergent, then is pumped up a specially designed portal and back onto the clothes in a cascade effect. This wash action thoroughly dissolves and activates the detergent.

The concentrated solution of detergent and water rapidly targets stains and soils at the fibre-level of fabrics, boosting soil removal and accelerating the wash process.

Note: the detergent activating wash on the 'Sports' cycle is cold temperature.

Wash 2 - Agitation wash (top-loader type wash)

After recirculating the sudsy water through your clothes for 4 minutes if you have selected 'Eco-Active™, On', your FabricSmart™ washer will fill with just enough cold water to suspend the clothes in solution. Agitation will then begin, moving soil away from the clothes. If you have selected 'Eco-Active™, Off' or the 'Sports' cycle, your washer will fill with just enough water at the temperature you have selected.

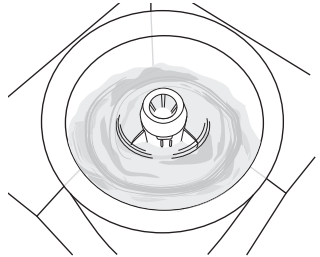
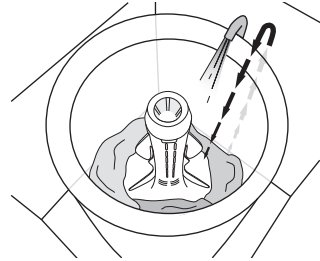





SORTING

Sorting

To get the best wash results it pays to sort your clothes before washing.

Care labels

The care label will tell you about the fabric of the garment and how it should be washed.

	Machine Washable Warm 40°C maximum Rinse Well Normal Spin
	Do not bleach
	Tumble drying possible, maximum 60°C
	Warm iron
	Do not dry clean

Examples of different care label symbols.

Soil

Sort clothes according to the type and amount of soil. Some soils suit warmer washes, eg oily soils, while others are best washed in cold water, eg mud, blood.

Colour

Sort white fabrics from coloured fabrics.

Lint

Wash lint givers and lint collectors separately. Where possible, turn lint collectors inside out (see table below).

LINT GIVERS	LINT COLLECTORS
Towels	Synthetics, eg polar fleece
Chenille	Corduroy
Nappies	Poly cotton
	Socks

LOADING

Loading

Check pockets

Loose items can damage both your washer and your clothes.

Close zippers, hooks and eyes

This is to make sure that these items do not snag on other clothes.

Mend any torn garments or loose buttons

Tears or holes may become larger during washing. Remove any loose bra wires as they can damage your washing machine and/or dryer.

Pretreat any stains

Make sure you use an appropriate surface to apply treatments. Do not use the lid or top of the machine, as damage may occur to these surfaces.

Make sure the water level suits the load size

If manually selecting the water level, select the correct water level by using the mark on the agitator nearest to the top of the load. Ensure the load does not extend above the bottom of the fabric softener dispenser cup, as splashing may occur.

For a balanced load

- Place unfolded clothes firmly and evenly around the agitator, no higher than the bottom of the fabric softener dispenser cup.
- Do not wrap large items, such as sheets, around the agitator.
- A mixture of small and large items will wash best.

Note: in the unlikely case of an out of balance load, refer to the Levelling instructions on page 9 to check the machine is correctly levelled.

IMPORTANT!

Please do not, under any circumstances, attempt to wash an electric blanket in your washer. Also, we do not recommend that you wash curtains in your washer. Sunlight makes them brittle and they may disintegrate during washing.

DETERGENT

Choosing the right detergent

- We recommend using domestic laundry detergent. Use powder or liquid detergent for 'Top Loader' machines.
- When washing wool items, remember to use a detergent specifically recommended for woollens.
- Soap flakes or granulated soap powders should not be used in your washer.
- Pods - Detergent pods are a 'no mess' alternative to powdered or liquid detergent. They must be placed in the bowl before loading your clothes.

How much detergent?

Follow the instructions on the back of the detergent packet as a guide to the correct amount of detergent to use. The correct amount of detergent will vary, depending on the amount of soil in your clothes and the size of your load. Jeans and work clothes may need more detergent, while towels usually need less. The larger your load, the more detergent you may have to add.

Adding the detergent

Liquid or powdered detergents

- ① Remove the fabric softener dispenser cup.
- ② Pour liquid or powder detergent down the centre of the agitator. Pre-dissolving detergent in warm water (before adding it to the machine) when washing in cold water can improve the performance of the detergent.
- ③ Replace the fabric softener dispenser cup (this prevents small articles falling down the centre of the agitator).

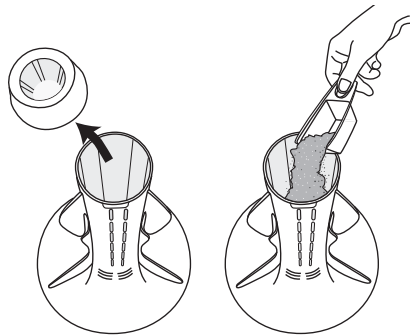

Adding your detergent

IMPORTANT!

We do not recommend you use nappy sanitisers or bleach to soak items in your FabricSmart™ washer. These products are very corrosive to metal surfaces and may seriously damage your machine.

FABRIC SOFTENER

How the fabric softener is dispensed

The fabric softener goes into the dispenser cup on the top of the agitator. During the rinse the machine spins to release the fabric softener, delivering it down the agitator stem as the machine fills for the final deep rinse.

If fabric softener is not added to the washer correctly, it may contribute to 'scrud' (described below).

Note: The 'Bulky' and 'Quick' cycles and 'Eco Rinse' option are not designed to be used with fabric softener as the fabric softener will not be dispersed correctly.

How much fabric softener?

Always follow the manufacturer's recommendations on the fabric softener packaging for the correct dosage. The ring on the dispenser cup is a guide only for the maximum amount of fabric softener to add for a full load. Smaller loads require less fabric softener.

Cleaning the dispenser

When using fabric softener, rinse your dispenser at the end of each wash.

- ① Separate the cup from the dispenser body by pushing downward on the base of the cup.
- ② Rinse both parts of the dispenser using warm soapy water.

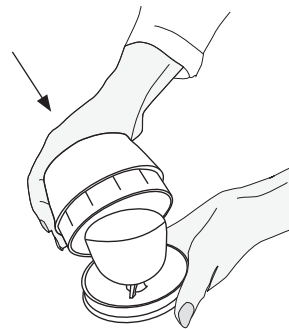

To separate, push cup away from dispenser with thumb

Scrud

Scrud is the name given to the waxy build-up that can occur within a washer when the fabric softener comes into contact with detergent. This can happen when fabric softener is not added to the machine correctly. This build-up is not brought about by a fault in the machine. If scrud is allowed to build up in the machine, it can result in stains on your clothes and/or an unpleasant smell in your washer.

If you wish to use fabric softener we recommend:

- Using fabric softener sparingly.
- When filling the dispenser, do not splash or overfill.
- Clean the dispenser as soon as the cycle has finished.
- Clean your machine regularly (refer to the 'Caring for your washer' section).
- Cold water washing increases the chance of a build-up of scrud occurring. We recommend a 'Warm' or 'Hot' wash at regular intervals, eg approximately every 5th wash.
- Fabric softener of a thinner consistency is less likely to leave residue in the dispenser and contribute to a build-up.

WASH CYCLES

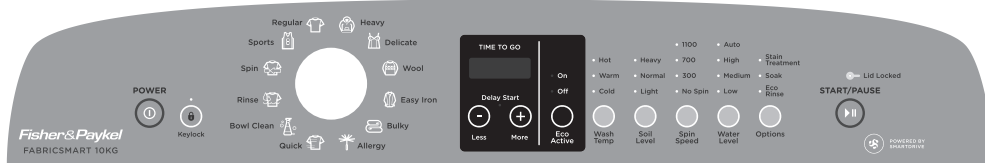

CYCLE	DESIGNED FOR	WASH TIME*	WASH ACTION	WASH TEMP	RINSE	MAX SPIN SPEED	SPIN TIME**
Regular***	For normally soiled everyday cotton loads, eg t-shirts, shorts, shirts.	11 - 15 minutes	Regular	Warm/Cold	Spray/Deep rinse	1100 rpm	6 minutes
Heavy	Recommended cycle for heavily soiled durable garments, eg tea towels, children's clothes.	13 - 19 minutes	Heavy	Warm	Spray/Deep rinse	1100 rpm	6 minutes
Delicate	Designed for delicate, lightly soiled clothes and recommended for all 'Hand wash only' items.	3 - 7 minutes	Delicate	Warm/Cold	Spray/Deep rinse	300 rpm	4 minutes
Wool	Designed for machine washable woollen items.	2 - 6 minutes	Delicate	Warm/Cold	Spray/Deep rinse	300 rpm	4 minutes
Easy Iron	Recommended cycle for items susceptible to creasing, eg shirts, dress trousers.	7 - 11 minutes	Regular	Warm/Cold	Spray/Deep rinse	700 rpm	6 minutes
Bulky	Recommended cycle for washing bulky items.	6 - 10 minutes + 30 minute Soak	Bulky	Warm	2 Deep rinses	300 rpm	6 minutes
Allergy	Recommended cycle people with skin and other sensitivities.	11 - 17 minutes	Regular	Hot	Sprays/2 Deep rinses	1100 rpm	6 minutes
Quick	For washing lightly soiled garments in a faster time.	1 - 5 minutes	Regular	Warm/Cold	Spray/Deep rinse	1100 rpm	4 minutes
Sports	Designed for sports items.	13 - 17 minutes	Sports	Warm	Spray/Deep rinse	1100 rpm	6 minutes
Bowl Clean	For maintaining the cleanliness of your washer.	Periodic agitation during a 2 hour soak	Delicate	Hot	Spray/Deep rinse	700 rpm	6 minutes
Rinse	This cycle allows you to select 'Rinse' and 'Spin' only.	n/a	Regular	Cold	Spray/Deep rinse	700 rpm	6 minutes
Spin	This cycle gives you the ability to select a 'Spin' cycle only. This cycle also allows you to customise the spin speed to suit your needs.	n/a	n/a	n/a	n/a	1100 rpm, or as selected	6 minutes

* Refers to the agitation time in the 'wash' part of the cycle, not the total time taken to complete a cycle.

** Refers to the length of time when at the maximum spin speed.

*** The 'Regular' cycle, with 'Eco-Active™', 'On', 'Normal Soil' and 'Eco Rinse' selected is the recommended water and energy saving cycle for normally soiled, everyday washing.

WASH OPTIONS

Water Level

Auto water level

Your washer has the ability to automatically select the most efficient water level for the load.

- ① Place your clothes in the machine.
- ② Select the wash cycle (and select 'Auto' water level if not automatically selected).
- ③ Touch ►II. The machine will automatically fill to the correct water level for the load, for both phases of the wash.

- When washing an unusual load, eg large bulky garments, items or pillows, we recommend you select the 'Bulky' cycle.
- If there is already water in the bowl, it is best to manually select the water level.

Manual water level selection

The agitator has five levels marked on its stem that can be used to help you select the correct water level. Select the correct water level by using the mark nearest to the top of the load.

- The levels marked on the agitator do not correspond exactly to the level of the water. They indicate the level of dry clothes suitable for the water level.
- Your washer may occasionally add water during agitation. This is to maintain the water level due to the release of air trapped in the garments.
- Out of balance loads, tangling or splash-over can be caused by selecting a water level that is too high.

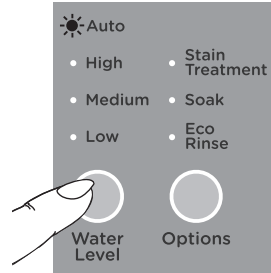

Selecting 'Auto' water level

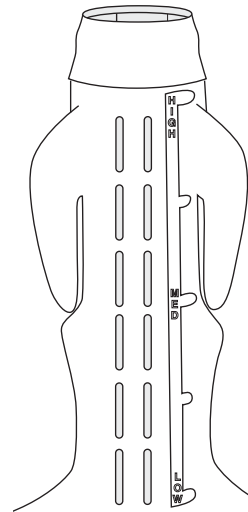

Water level guide on agitator

WASH OPTIONS

Wash Temp

FabricSmart™ offers 5 wash temperatures, and an additional setting, 'Controlled Cold'.

The wash temperature selected is used in the detergent activating part of the wash except for the 'Sports' cycle (refer to the 'Eco-Active™ wash' section). If Eco-Active™ is 'On' the temperature will be lower for the second part of the wash. When Eco-Active™ 'Off' is selected, the bowl will fill with the wash temperature selected.

Note: for the 'Allergy' cycle the bowl fills with water at the temperature selected.

The temperature of cold tap water varies widely depending on your location and the season. We have developed 'Controlled Cold', which adds a small amount of warm water, when necessary, to raise your cold water wash to 20°C for a more effective wash (refer to the 'Changing pre-set options' section for detail on how to set 'Controlled Cold' as the default temperature for your cold water wash).

Soil Level

Your clothes and other washable items sometimes need more or less cleaning than others. The 'Soil Level' option lets you adjust the wash to suit the amount of soil in your load. For example, for dirty clothes, select 'Heavy' and for items that are only lightly soiled, select 'Light'. This adjusts the wash time accordingly to give the load the right amount of agitation in order to remove the soil.

Spin Speed

Your washer offers 3 spin speeds: 1100 rpm, 700 rpm and 300 rpm, plus an additional 'No Spin' option. Simply increase or decrease your spin speed by touching the 'Spin Speed' button.

Note: some spin speeds are not available on some cycles for best clothes care (eg 'Delicate' cycle).

Use the 'No Spin' option to:

- Remove drip dry garments from a mixed load before the wash goes into 'Spin'.
- Minimise the clothes creasing when they are left to sit in the bottom of the bowl at the end of the cycle.

When you have selected 'No Spin', the cycle will end after the rinse allowing you to remove drip dry items before you spin the remaining items. Once drip dry items have been removed, touch **ⓘ**, select the 'Spin' cycle (change the spin speed if necessary, eg select '300' for delicate or creasable items) and touch **▶||**.

Your washer will optimise the spin speed according to the level of out of balance in the load.

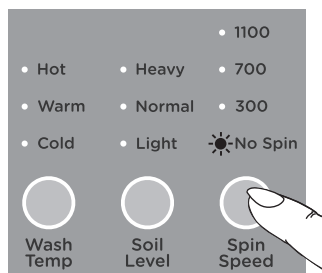

Selecting the 'No Spin' option

WASH OPTIONS

Options

Stain Treatment

If you have stains in your wash load you can add a number of short soaks to the wash to help remove these by selecting the 'Stain Treatment' option.

Soak

Use the 'Soak' option to soak clothes during the wash phase. Ensure items are colourfast before using 'Soak'.

When you select 'Soak' your washer will soak for a period of 2 hours before completing 'Rinse' and 'Spin'. During 'Soak' your washer will agitate for a few seconds every minute.

Note: if the 'Soak' option is selected on a 'Quick' cycle, the soak time will be one hour only.

To exit 'Soak', touch ►|| and select 'Rinse'. Change the spin speed if necessary (eg select '300' if washing delicate or creasable items and touch ►||).

Eco Rinse

Use the 'Eco Rinse' option to save water. The 'Eco Rinse' option uses a spray rinse which has been specially designed to use at least 25% less water than a traditional rinse. Use this option when you want to use less detergent and less water. However, if you have low water pressure or sensitive skin it is better to use a traditional rinse.

The 'Eco Rinse' option has not been designed to be used with fabric softener, as it does not have a deep rinse to dispense the softener correctly. Fabric softener should not be used if this option is selected.

Note: the 'Eco Rinse' option is only available on the 'Regular', 'Heavy' and 'Sports' cycles. If you try to select this option on other cycles your washer will skip over the option. The wash cycle will take slightly longer when the 'Eco Rinse' option is selected.

There are some wash loads that may not suit being washed using the 'Eco Rinse' option. For instance, loads that have a lot of sand or sawdust in them or garments where the colour still runs from them.

IMPORTANT!

DO NOT use your washer to soak items in bleach or sanitiser, and if you've soaked items in a bucket, do not tip the contents of the bucket into your machine. The chemicals in these products are very corrosive to metal surfaces and can damage your washer. Rinse and wring items out thoroughly before placing them in your machine.

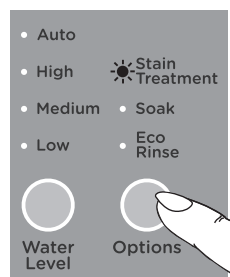

Selecting the 'Stain Treatment' option

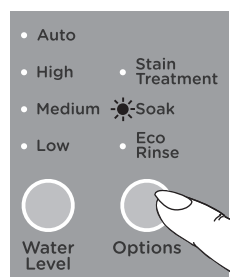

Selecting the 'Soak' option

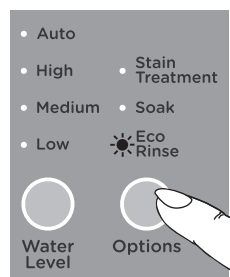

Selecting the 'Eco Rinse' option

WASH OPTIONS

Delay Start

The 'Delay Start' option can delay the start of the wash cycle by 5 minutes up to 18 hours. This can be useful to time your washing to finish when you arrive home from work, or to start once you have finished in the shower. Simply touch the 'More' **+** button to scroll through to your desired delayed start time, or to turn delay start off. Touch **▶||** to confirm your selection and start the countdown.

Note: we suggest that you avoid using 'Delay Start' for damp, non-colourfast items as this may cause dye run to occur.

Clothes care safeguards

To avoid accidentally damaging your clothes there are a few options that your washer will not accept. For example, you cannot select a 'Hot' wash on the 'Delicate', 'Bulky', 'Easy Iron' or 'Wool' cycles.

WASH OPTIONS

Washing bulky items

Forcing large items into the machine may result in them being damaged during washing. Make sure there is enough room in the machine for items to move when being washed.

Some items float up during the wash (eg duvets/duonas, water-proof and water-resistant items and pillows). If they sit too high they may touch stationary parts of the machine during agitate or spin. To minimise the chance of this happening, ensure bulky items are pushed back down into the water after fill, and pushed down again to sit below the medium high water level mark on the agitator before 'Spin'. Select a 'Spin Speed, 300'.

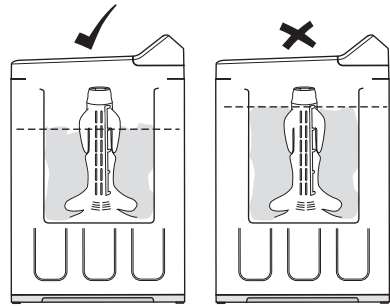

Bulky items should sit below the medium high water level mark.

IMPORTANT!

To prevent an out of balance load or splash-over we recommend washing all bulky items, including water-proof and water-resistant items, on the 'Bulky' cycle.

If you wish to re-spin the load at a faster speed make sure the load is sitting below the medium-high mark before spinning.

Washing woollens

Many woollen items carry a 'Machine Washable' care claim. The fibres of these woollens have been treated to prevent felting when they are machine washed.

- Check the care label.
- Use a wool detergent.
- Use the specially designed 'Wool' cycle.
- Hand washed woollens may be spun in your washer (select 'Spin Speed, 300').
- To dry woollens lie them flat on a towel and pat into shape. Dry out of direct sunlight.

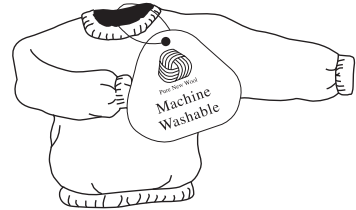

Most handcrafted garments are not made of machine washable wool and we recommend that you wash them by hand only.

Note: some wool underlays and sheepskin products can be washed in a washing machine but could produce excessive amounts of lint that may cause pump blockages.

CUSTOMISING WASH CYCLES

To customise a cycle

You can program your FabricSmart™ washer to remember the wash options you prefer for each wash cycle. For instance, you may want to set the 'Regular' cycle to default to a 'Warm' wash or set 'Heavy' cycle to include a 'Soak'.

- 1 Touch **I**.
- 2 Turn the dial to select the wash cycle you wish to customise, eg 'Regular'.
- 3 Touch and hold the button of the option you want to customise, eg 'Wash Temp' for 3 seconds. You will hear 2 quick beeps and the wash cycle icon will flash. The screen will display **SEt**.
- 4 Select your preferred setting, and any other options you wish to customise for this cycle.
- 5 Touch the **▶||** button to store your customised cycle (a long beep will sound to confirm the changes have been saved).

To change your customised wash cycle simply repeat these steps.



Customising a wash cycle, eg 'Regular' cycle

CHANGING PRE-SET OPTIONS



Option Adjustment mode

After using your washer a number of times you may want to fine tune some of the options to suit your wash needs.

There are a number of pre-set options, which can be altered:

- ① The wash temperatures, including changing the 'Cold' wash temperature to 'Controlled Cold'.
- ② The out of balance recovery routine.
- ③ The number of beeps at the end of the cycle.
- ④ Resetting to factory default settings.

To enter Option Adjustment mode

- ① Turn machine on at the wall but **do not** touch ①.
- ② Touch and hold the  and  buttons together for 3 seconds. You will hear 3 quick beeps indicating you have entered Option Adjustment mode. The machine will show the default setting for the 'Cold' wash temperature.
 - **The diagram on page 29 shows how the wash cycle icons relate to the options you can change.**
 - The 'Changing pre-set options' section explains the different options in more detail.
- ③ Use the dial and buttons on the panel to make your changes to the pre-set options.
- ④ Press ① to return to normal mode. Your washer will automatically remember your changes.

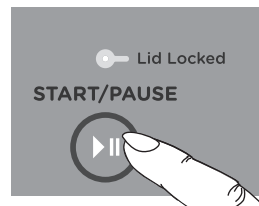

Entering Option Adjustment mode

To change or reset any of the options, repeat the above steps.

CHANGING PRE-SET OPTIONS

Adjusting your options

- ① Enter Option Adjustment mode (refer to the 'Changing pre-set options' section).
- ② The diagram below shows how the wash cycle icons relate to the options you can change. It also shows what will be displayed when you first enter Option Adjustment mode. Options you can change are accessible using the 'Heavy' 'Delicate', 'Wool' and 'Easy Iron' cycles.

Use this diagram to help you adjust the options, ie select the 'Heavy' cycle button to modify the wash temperature, select the 'Delicate' cycle button to change the out of balance (OOB) recovery process, and so on.



FabricSmart™ Option Adjustment mode

- ③ Use the 'Delay Start', 'More' + button on the panel to scroll through the available settings of your selected option, eg to increase or decrease the temperature of your warm wash temperature, or to change the number of beeps at the end of the cycle.



Changing the pre-set options

CHANGING PRE-SET OPTIONS

Wash temperatures

All wash temperatures can be individually adjusted if you think they are too hot or too cold. Note: the hot temperature will be the same as the hot water supply temperature.

- 1 Enter Option Adjustment mode (refer to page 28).
- 2 Select the 'Heavy' cycle.
- 3 Select the wash temperature you want to adjust, eg 'Warm', by touching the 'Wash Temp' button. The digital display screen displays the current setting.
- 4 Touch the 'More' **+** or 'Less' **-** button to increase or decrease to the desired temperature (the temperature setting options will scroll around). Each increment is equal to approximately 0.5°C.



Adjusting the temperature setting, eg increasing the WARM wash temperature by 2°C

Controlled Cold

If the temperature of your cold water supply is very low and you choose to do a 'Cold' wash, you will not get an effective wash. The 'Controlled Cold' option solves this problem by adding a small amount of hot water to raise the temperature of the wash to approximately 20°C.

- 1 Enter Option Adjustment mode (refer to page 28).
- 2 Select the 'Heavy' cycle.
- 3 Select 'Cold' wash temperature by touching the 'Wash Temp' button (if not already selected).
- 4 The digital display shows the temperature adjustment possible. The default setting is *LAP*, which is the same temperature as the incoming water from the cylinder for cold water.
- 5 To get 'Controlled Cold', touch the 'More' **+** button until *20* is displayed. Your washer will now adjust the cold temperature to approximately 20°C. Each of the remaining settings equals an approximate 0.5°C temperature increase or decrease from this point (excluding *LAP*).
- 6 Touch **1** to save the setting (if you wish to make no other changes).

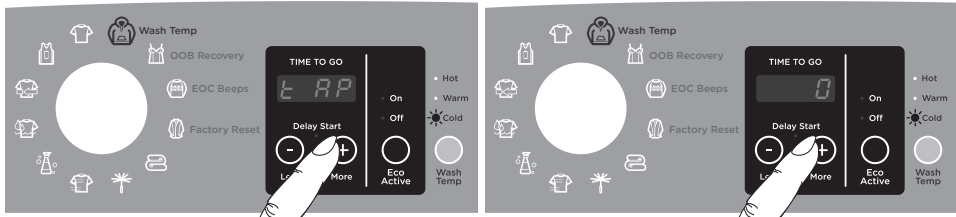

Changing the cold wash temperature setting from cold tap to 'Controlled Cold'

Note: if you always use 'Cold' or Controlled Cold' water, we recommend that a 'Warm' or 'Hot' wash be used regularly, eg every 5th wash should be at least a warm one. Warm water is needed to help maintain the cleanliness of your machine.

CHANGING PRE-SET OPTIONS

Out of balance recovery routine

When your washer is spinning it can sense if the wash load is out of balance. If an out of balance load is detected, the machine will stop and re-try spinning one more time. If it still senses an unbalanced load there are two options the machine can take.

Automatic recovery OFF (the default setting)

Your washer will stop, beep, and show $OUT OF BAL$ in three phases on the display screen. You must redistribute the load more evenly yourself. Use this option if you wish to conserve water.

Automatic recovery ON

Your washer will try to automatically correct the out of balance load. It will fill with water and agitate to redistribute the load before trying to spin up again.

To change the out of balance (OOB) recovery option:

- 1 Enter Option Adjustment mode (refer to page 28).
- 2 Select the 'Delicate' cycle.
- 3 Touch the 'More' $+$ button to turn automatic recovery on or off.



Changing the OOB routine

End of cycle beeps

The beeps signalling the end of the cycle can be increased or decreased. The default setting is 5 beeps.

To modify the number of beeps sounding at the end of the cycle:

- 1 Enter Option Adjustment mode (refer to page 28).
- 2 Select the 'Wool' cycle.
- 3 Touch the 'More' $+$ or 'Less' $-$ button to increase or decrease the number of beeps, or for no beeps to sound at the end of the cycle.



Modifying the number of beeps to signal the end of the cycle

Remember, to save changes and exit from the Option Adjustment mode (ie to return to normal operating mode), touch the I button.

CHANGING PRE-SET OPTIONS

Factory reset

You can reset your washer to the settings it left the factory with:

- 1 Enter Option Adjustment mode (refer to page 28).
- 2 Select the 'Easy Iron' cycle.
- 3 The display will show *r 5 t*. Touch and hold ►|| for 3 seconds to reset your washer to its factory settings.

Note: this action will reset the washer to the default settings, exit Option Adjustment mode and restart the washer in normal operating mode.

Touch ⓘ to exit if you do not wish to reset your washer.



Changing the washer back to the factory default settings

CARING FOR YOUR WASHER

When you have finished using your washer

- Turn off the taps to prevent the chance of flooding should a hose burst.
- Turn off the power at the wall.

Cold water washing

If you always wash with cold water, we recommend that a 'Warm' or 'Hot' wash be used at regular intervals, eg every 5th wash should be at least a warm one.

Cleaning your washer

Note: ensure the power is turned off at the wall before cleaning your washer.

- Clean the surfaces of your washer with a soft damp cloth only and wipe dry. Do not use scouring or spray cleaners as they can damage the paint, plastic and panel surfaces.
- Clean the fabric softener dispenser after each cycle using warm soapy water.
- To remove the agitator for cleaning, unscrew the nut down the centre of the agitator by turning anti-clockwise.
- The SmartTouch™ Control Dial and soft close lid are not designed to be removable for cleaning. Do not attempt to remove the dial or lid.

IMPORTANT!

The agitator must be fully pushed onto the shaft when refitting. Tighten the nut firmly by hand. Ensure the agitator is not loose.

Cleaning the inside of your washer

It is important that you occasionally clean the inside of your machine. Your FabricSmart™ has a 'Bowl Clean' cycle specifically for this purpose and will remind you every 100 cycles to run this cycle (the 'Bowl Clean' cycle icon will flash to alert you), or we recommend completing this cycle 5 – 6 times a year. We suggest that you do not have any items in the washer when you run this cycle.

Cleaning steps

- ① Add approximately 2 full scoops of a good quality powdered detergent directly into the detergent dispenser.
- ② Touch **ⓘ** to turn your machine on and select the 'Bowl Clean' cycle.
- ③ Touch **▶||** to start the cycle (refer to the 'Wash cycles' section for cycle details).

CARING FOR YOUR WASHER

Products that might damage your washer

- Concentrated bleaches, nappy sanitisers and hydrocarbon solvents (eg petrol and paint thinners) can cause damage to the paintwork and components of your washer. Be careful when washing garments stained with solvents as they are flammable. DO NOT put them in your dryer.
- Do not use pre-treatment sprays or liquids on or near your washer as they can damage your machine's control panel and plastic surfaces.
- Use of dyes in your washer may cause staining of the plastic components. The dye will not damage the machine but we suggest you thoroughly clean your washer afterwards. We do not recommend the use of dye strippers in your washer.

Washer sounds and beeps

Your washer will make sounds that you will not have heard from other clothes washers.

- While draining, your machine may give several low thuds. Your machine is checking that the water has drained before spinning.
- Your washer will beep if you have used 'No Spin' and at the end of the cycle.
- If your machine is beeping continuously or giving a musical series of beeps, refer to the 'Before you call for service' section.

Automatic lint system

Your washer has a self-cleaning lint system. The machine automatically separates the lint from the wash water, traps the lint between the inner and outer bowls and flushes it out at the end of the wash.

Saving water

Water saving tips

- Bigger loads are more efficient than small loads.
- Use the 'Eco Rinse' option (refer to the 'Wash options' section).

Recycling the wash water

Your washer also offers several ways of reusing the wash and rinse water.

- ① Select 'Soak' on the first wash cycle.
- ② Remove the clothes at the end of the wash phase and add the second load to the wash water.
- ③ Select the wash cycle for the second load. You may need to add extra detergent.
- ④ Remove the second load at the end of the cycle.
- ⑤ Replace the first load, select 'Rinse' and complete the cycle.

BEFORE YOU CALL FOR SERVICE

Please read the following pages before you call for service.

Your washer is capable of diagnosing its own problems. If your washer gives a musical series of beeps every 5 seconds it is telling you that it has a problem which you can solve using the checklist below.

Your machine sounds a musical series of beeps* every 5 seconds and displays a user warning on the screen:

PROBLEM	DISPLAYED AS	WHAT TO DO
The machine is not getting any hot water.	<i>no</i> <i>hot</i>	Hot water supply is not hot enough to maintain the wash temperature you have selected. Select a lower wash temperature. <hr/> Inlet hose filters may be blocked. <hr/> There may be a kink in the hose. <hr/> Hot tap has not been turned on. <hr/> Inlet hoses are connected to the wrong taps.
The machine is not getting any cold water.	<i>no</i> <i>ld</i>	Cold tap has not been turned on. <hr/> Inlet hose filters may be blocked. <hr/> There may be a kink in the hose. <hr/> Inlet hoses are connected to the wrong taps. <hr/> Cold water temperature exceeds recommended limits (refer to page 7). <hr/> The flow rate of the supply water is too slow.
The machine is not getting any water.	<i>no</i> <i>tap</i>	The taps have not been turned on. <hr/> Inlet hose filters may be blocked. <hr/> The hoses may be kinked. <hr/> The drain hose is too low or the drain hose is pushed into the standpipe too far and the water is siphoning out of the machine (refer to page 6). <hr/> The flow rate of the supply water is too slow.
The machine is out of balance.	<i>out</i> <i>of</i> <i>bal</i>	Wash load is out of balance. Ensure the machine is stationary. Manually redistribute the load. <hr/> Check the machine is level (refer to page 9).
The machine has too many suds.	<i>Sud</i> <i>LOC</i>	The machine has a suds build-up (too much detergent may have been used for the amount of soil in the load). Wait for suds to dissolve (about 20 min). Rinse clothes using a deep rinse. <hr/> Check the standpipe height does not exceed 2400 mm. <hr/> If the symptom persists, call your Fisher & Paykel dealer or Authorised Repairer.

BEFORE YOU CALL FOR SERVICE

PROBLEM	DISPLAYED AS	WHAT TO DO
The lid can't lock or the lid is open.	<i>Lid</i>	Make sure the lid is closed.
	<i>LOC</i> <i>OPN</i>	Press ► (refer to page 15). If the symptom persists call your Fisher & Paykel dealer or Authorised Repairer.
The machine is overloaded.	<i>too</i>	The machine is overloaded and can not agitate.
	<i>FUL</i>	Ensure the machine is stationary. Remove items until the remaining ones can move freely. Select a higher water level.

* The beeps are the same sound your washer makes when you turn it on at the wall.

FAULT CODES

When a continuous series of beeps is sounded, all the lights turn off on the control panel and a number appears on the display, a fault has occurred. The washer will automatically enter this mode if a fault occurs. The fault code will be displayed as *E r r* followed by a number on the digital display. To stop the sound, touch any button and perform the following steps:

- ① Turn your machine off at the power point.
- ② Wait 1 minute and turn it back on.
- ③ Check your machine is correctly levelled (refer to page 9).
- ④ Remove your wash load.
- ⑤ Perform a 'Rinse' cycle.
- ⑥ If the fault re-occurs repeat steps ① and ②.
- ⑦ If the machine will still not work you will be required to call a Fisher & Paykel Authorised Repairer to arrange service (refer to the 'Customer Care' section). Record the fault code number displayed and the serial number of your washer (located on the rear of the machine) before calling. The fault code will indicate to the repairer what the problem could potentially be.

If a fault code is being displayed, you can still turn your washer off by pressing ①.

TROUBLESHOOTING

The following is a list of problems you may encounter when using this appliance and some suggestions that may help to correct the problem. If you still have problems, please contact your Fisher & Paykel Authorised Repairer.

Solving operating problems

PROBLEM	POSSIBLE CAUSES	WHAT TO DO
Washer not turning on.	Power not switched on at the wall.	Switch the power off at the wall and wait 60 seconds before turning power on again.
	Household power supply not working.	Try plugging in another electrical appliance.
	Keylock may be activated.	Try holding down the ⓘ button for 2 seconds. Refer to page 14.
Washer not filling with water when ▶II pressed.	Inlet taps not turned on.	Check that both the hot and cold taps are turned on.
	Blocked inlet hose filters.	Clear blockages from inlet hose filters.
	'Delay Start' is set.	Refer to page 25 for information about the 'Delay Start' function.
Washer is filling continuously.	Drain hose is not installed correctly.	Ensure drain hose is located in standpipe or tub. Ensure standpipe is at least 850 mm high but no more than 2400 mm high.
	Machine could be siphoning.	To prevent siphoning ensure the drain hose does not extend more than 20 mm from the end of the hose guide. Refer to the 'Installation instructions' section.
Washer is not spinning properly.	The load could be out of balance.	Pause machine and manually redistribute the load.
		Check the machine is level and does not rock in any direction. Refer to page 9.
		Check the machine does not have suds build up.
Spin speed sounds slower than normal.	Clothes are unevenly distributed in the bowl.	Washer has compensated by lowering the spin speed.
	The outer wash bowl may still be hot from being filled with hot water.	The washer has slowed the spin speed as a protective measure.

TROUBLESHOOTING

Solving operating problems

PROBLEM	POSSIBLE CAUSES	WHAT TO DO
Machine is continually going out of balance.	Machine may not be level.	Check the machine is level and does not rock in any direction. Refer to page 9.
	Too much water for the load	Ensure an appropriate water level is selected for the load size (or select 'Auto' water level). Refer to page 31 to change the out of balance recovery mode.
Too much or too little water when filling on auto water level.	The machine needs to determine the correct water level for the load.	Refer to the 'Wash options' section for more information.
	Some loads do not suit 'Auto' water level, eg pillows.	Manually select the most appropriate water level for the load.
Machine is making noises.	Banging.	Load is out of balance. Press ► and redistribute the load.
	Other noises.	Refer to the 'Caring for your washer' section.
Small puddle coming from under the machine.	The water level is too high for the amount of clothes and has caused excessive splashing.	Select a lower water level. Refer to page 22 for more information.
	Large bulky garments (eg pillows duvet) can cause splashing.	Wash on the 'Bulky' cycle. Refer to page 26.

TROUBLESHOOTING

Solving wash problems

PROBLEM	POSSIBLE CAUSES	WHAT TO DO
Creasing.	Overloading of the washer.	Try reducing load size.
	Inappropriate cycle selection.	Choose 'Easy Iron' or 'Delicate' cycle as these cycle have been designed to minimise creasing.
	Spin speed too high.	Try selecting a lower spin speed. Do not leave wet clothes to sit in the washer or laundry basket.
	Wash temperature too high for items.	Try selecting a lower wash temperature. Sort your load so that items of similar weight are washed together.
Poor soil removal.	Wash cycle selected not suited to soil level in load.	Are you using the most appropriate wash cycle for the amount of dirt?
	Warm wash water is too cold.	Refer to page 30.
	Not enough detergent for load size or amount of soil.	Refer to the detergent package for the manufacturers recommended dosage.
	White clothes are better washed separately.	Separate light and heavily soiled items, as clothes can pick up soil from dirty wash water.
	Cold water wash is too cold.	Refer to page 30.
	Select the wash temperature according to soil type.	Blood and mud are better washed in cold water, while oily soils are better washed in warmer water.
	Overloading the washer.	Try reducing your load size.
	Loads made up of articles of varying sizes will wash better.	A full load of sheets may not wash as well.
	Hard water requires more detergent than soft water.	If you have hard water, try adding more detergent. Try selecting 'Heavy' option using the soil level button.
	Tangling.	Washing with too much water (underloading) can cause the clothes to tangle around one another.
Items wrapped around the agitator when loading.		Place items, especially sheets, in the bowl as loose parcels.

TROUBLESHOOTING

Solving wash problems

PROBLEM	POSSIBLE CAUSES	WHAT TO DO
Linting.	Some items in load more likely to release or pick up lint.	Wash lint givers (eg towels, flannelette sheets) separately from lint collectors (eg synthetic fabrics).
	Overloading the washer.	Try reducing your load size.
	Not enough detergent to hold the lint in suspension.	Try using more detergent.
	Overdrying in a dryer can cause a build-up of static electricity in synthetic fabrics and cause them to attract lint.	Try not to over dry items when using your dryer.
Detergent residue.	Over loading the washer.	Try reducing your load size.
	Did you use the recommended amount of detergent?	Try using less detergent.
	Some detergents need to be pre dissolved before being added to the washer.	Check the detergent instructions.
	Cold ambient temperatures, cold washes and/or short agitation times may not allow the detergent to dissolve properly.	Try pre-dissolving the detergent before adding it to the machine.
Black or grey marks on clothes.	A build up caused by the interaction of fabric softener and detergent can flake off and mark clothes.	Refer to page 20.
	Insufficient detergent for the amount of soil on the clothes, can result in grey marks on clothes.	Make sure you are using enough detergent for the amount of dirt in your wash load. Refer to page 19. Empty machine and put through a 'Bowl Clean' cycle. Refer to page 33.
Dye transfer.	Washing dark coloured and light coloured items together.	Remember to separate whites and colours.
	Keep wet or damp dark coloured and light coloured items separate.	Wash and dry non-colourfast clothes separately. Non-colourfast clothes left sitting in a washer or laundry basket can transfer dye onto other clothes.

MANUFACTURER'S WARRANTY

You automatically receive a 2 year Manufacturer's Warranty with the purchase of this clothes washer covering parts and labour for servicing within the country of purchase.

Fisher & Paykel undertakes to:

Repair or, at its option, replace without cost to the owner either for material or labour any part of the product, the serial number of which appears on the product, which is found to be defective within TWO YEARS of the date of purchase.

If your product qualifies, you also receive an additional EIGHT YEAR parts only Manufacturer's Warranty on your Direct Drive motor. This additional 8-year Manufacturer's Warranty commences on the day following the expiry of the 2-year Manufacturer's Warranty and excludes the motor controller and labour. Fisher & Paykel will repair (as to parts) or, at its option, replace any Direct Drive motor (but not the motor controller) which is found to be defective within this additional Manufacturer's Warranty period. You will be responsible for any labour costs.

To see if your product qualifies for this additional Manufacturer's Warranty, refer to our website: www.fisherpaykel.com/smartdrive

Note: these Manufacturer's Warranties are an extra benefit and do not affect your legal rights.

These Manufacturer's Warranties DO NOT cover

- (A) Service calls which are not related to any defect in the product. The cost of a service call will be charged if the problem is not found to be a product fault. For example:
 - ① Correcting the installation, eg removal of bottom packer and transit bolts (front loading washers), levelling the machine, adjustment of the drain to correct siphoning, noises, crossed, kinked or leaking inlet hose connections, turning on water, noises caused by the waterhammer or power supplies.
 - ② Providing instruction on use of the product or changing the set-up of the product, eg instruction on correct use of detergents and fabric softeners.
 - ③ Replacing fuses in, or correcting house wiring or correcting house plumbing, eg unblocking drains.
 - ④ Correcting fault(s) caused by the user.
 - ⑤ Noise or vibration that is considered normal, eg spin sounds, user warning beeps.
 - ⑥ Correcting damage caused by pests, eg rats, cockroaches, etc.
 - ⑦ Water on the floor due to incorrect loading or excessive suds.
 - ⑧ Blocked pumps, removal of foreign objects/substances from the machine, including the pump and inlet hose filters, eg bra wires, bread tags, nails, grit, crud, etc.
 - ⑨ Correcting corrosion or discolouration due to chemical attack.
- (B) Defects caused by factors other than:
 - ① Normal domestic use; or
 - ② Use in accordance with the product's user guide.
- (C) Defects to the product caused by accident, neglect, misuse or 'act of God'.
- (D) The cost of repairs carried out by non-authorized repairers or the cost of correcting such unauthorised repairs.
- (E) Normal recommended maintenance as set out in the product's user guide.

MANUFACTURER'S WARRANTY

- Ⓕ Repairs when the appliance has been dismantled, repaired or serviced by other than a Fisher & Paykel Authorised Repairer or the selling dealer.
- Ⓖ Pick-up and delivery.
- Ⓗ Transportation or travelling costs involved in the repair when the product is installed outside the Fisher & Paykel Authorised Repairer's normal service area.

This product has been designed for use in a normal domestic (residential) environment. This product is not designed for commercial use (whatsoever). Any commercial use by a customer will affect this product's Manufacturer's Warranty.

Service under these Manufacturer's Warranties must be provided by a Fisher & Paykel Authorised Repairer (refer to the 'Customer Care' section at the back of this book). Such service shall be provided during normal business hours. This Manufacturer's Warranty certificate should be shown when making any claim.

For Australian customers

This Manufacturer's Warranty is an extra benefit and does not affect your legal rights. Our goods come with guarantees that cannot be excluded under the Australian Consumer Law. You are entitled to a replacement or refund for a major failure and for compensation for any other reasonably foreseeable loss or damage. You are also entitled to have the goods repaired or replaced if the goods fail to be of acceptable quality and the failure does not amount to a major failure.

Please keep this user guide in a safe place.

CUSTOMER CARE

Before you call for service or assistance...

Check the things you can do yourself. Refer to your user guide and check:

- ① Your product is correctly installed.
- ② You are familiar with its normal operation.
- ③ You have read the 'Before you call for service', 'Fault codes' and 'Troubleshooting' sections at the back of the book.

If after checking these points you still need assistance or parts, please refer to your nearest Authorised Service Centre, Customer Care, or contact us through our website www.fisherpaykel.com.

In New Zealand if you need assistance...*

Call your Fisher & Paykel retailer who is trained to provide information on your appliance, or if we can be of any further help, please contact our Customer Care Centre.

Toll Free: 0800 FP CARE or 0800 372 273

Fax: (09) 273 0656

Website: www.fisherpaykel.com

Postal address: Fisher & Paykel Appliances Ltd, PO Box 58546, Botany, Auckland 2163

If you need service...*

Fisher & Paykel has a network of independent Fisher & Paykel Authorised Repairers whose fully trained technicians can carry out any service necessary on your appliance. Your dealer or our Customer Care Centre can recommend a Fisher & Paykel Authorised Repairer in your area.

In Australia if you need assistance...*

Call the Fisher & Paykel Customer Care Centre and talk to one of our Customer Care Consultants.

Toll Free: 1300 650 590

Fax: (07) 3826 9298

Website: www.fisherpaykel.com

Postal address: Fisher & Paykel Appliances Ltd, PO Box 798, Cleveland QLD 4163

If you need service...*

Fisher & Paykel has a network of qualified Fisher & Paykel Authorised Repairers responsible for servicing only Fisher & Paykel branded appliances. Our Customer Care Centre can recommend a qualified Fisher & Paykel Authorised Repairer in your area.

*If you call, write or contact our website please provide: your name and address, model number, serial number, date of purchase and a complete description of the problem. This information is needed in order to better respond to your request for assistance.

Product details can be found on the top left hand side of the console or back panel of the washer cabinet.

CUSTOMER CARE

Registration

Register your product with us so we can provide you with the best service possible.
To register your product visit our website: **www.fisherpaykel.com**

Complete and keep for safe reference:

Model _____

Serial No. _____

Purchase Date _____

Purchaser _____

Dealer _____

Suburb _____

Town _____

Country _____

www.fisherpaykel.com

Copyright © Fisher & Paykel 2014. All rights reserved.
The product specifications in this booklet apply to the specific products and models described at the date of issue. Under our policy of continuous product improvement, these specifications may change at any time. You should therefore check with your dealer to ensure this booklet correctly describes the product currently available.

NZ AU

424983 A 09.14