



Refrigerator user manual

English

Free Standing Appliance

imagine the possibilities

Thank you for purchasing a Samsung product.
To receive a more complete service,
please register your product at
www.samsung.com/register

条形码

DA68-01868A-18

SAMSUNG

features of your new refrigerator

KEY FEATURES OF YOUR NEW REFRIGERATOR

Your Samsung Refrigerator comes equipped with various innovative storage and energy-efficient features.

- **Twin Cooling System**

The Refrigerator and Freezer have separate evaporators. Due to this independent cooling system, the Freezer and Refrigerator cool more efficiently.

Additionally, this separate air flow system prevents food odor of one compartment from seeping into other compartments.

- **Bigger & Wider Space**

The wide shelf area provides enough space for larger items.

The wide freezer drawer also provides enough space for 2~3 turkeys.

- **Secure Auto Close**

The Secure Auto Close feature will automatically close a door that is slightly open.

- **Digital Display and Temperature Control**

- **Door Alarm**

A helpful beeper alerts you if a door is ajar.

SAMSUNG

For easy future reference, write the model and serial number down. You will find your model number and serial number on the left side of the refrigerator.











Model # _____
Serial # _____

safety information

SAFETY INFORMATION

- Before operating the appliance, please read this manual thoroughly and retain it at a safe place near the appliance for your future reference.
- Use this appliance only for its intended purpose as described in this instruction manual. This appliance is not intended for use by persons (including children) with reduced physical, sensory or mental capabilities, or lack of experience and knowledge, unless they have been given supervision or instruction concerning use of the appliance by a person responsible for their safety.
- Warnings and Important Safety Instructions in this manual do not cover all possible conditions and situations that may occur. It is your responsibility to use common sense, caution, and care when installing, maintaining, and operating your appliance.
- Because these following operating instructions cover various models, the characteristics of your refrigerator may differ slightly from those described in this manual and not all warning signs may be applicable. If you have any questions or concerns, contact your nearest service center or find help and information online at www.samsung.com.

Important safety symbols and precautions :

 WARNING	Hazards or unsafe practices that may result in severe personal injury or death .
 CAUTION	Hazards or unsafe practices that may result in minor personal injury or property damage .
	Do NOT attempt.
	Do NOT disassemble.
	Do NOT touch.
	Follow directions carefully.
	Unplug the power plug from the wall socket.
	Make sure the machine is grounded to prevent electric shock.
	Call the contact center for help.
	Note.

These warning signs are here to prevent injury to you and others.

Please follow them carefully.

After reading this section, keep it in a safe place for future reference.

It is hazardous for anyone other than an Authorised Service Person to service this appliance. In Queensland - the authorized Service Person MUST hold a Gas Work Authorisation or Licence for hydrocarbon refrigerants, to carry out Servicing or repairs which involve the removal of covers.

safety information



WARNING

SEVERE WARNING SIGNS FOR TRANSPORTATION AND SITE



- When transporting and installing the appliance, care should be taken to ensure that no parts of the refrigerating circuit are damaged.
 - Refrigerant leaking from the pipe work could ignite or cause an eye injury. If a leak is detected, avoid any naked flames or potential sources of ignition and air the room in which the appliance is standing for several minutes.
- In order to avoid the creation of a flammable gas-air mixture if a leak in the refrigerating circuit occurs, the size of the room in which the appliance may be sited depends on the amount of refrigerant used.
- Never start up an appliance showing any signs of damage. If in doubt, consult your dealer. The room where the refrigerator will be sited must be 1m³ in size for every 8g of R600a refrigerant inside the appliance. The amount of refrigerant in your particular appliance is shown on the identification plate inside the appliance.



WARNING

SEVERE WARNING SIGNS FOR INSTALLATION



- Do not install the refrigerator in a damp place or place where it may come in contact with water.
 - Deteriorated insulation of electrical parts may cause an electric shock or fire.
- Do not place this refrigerator in direct sunlight or expose to the heat from stoves, room heaters or other appliance.
- Do not plug several appliances into the same multiple power board.
The refrigerator should always be plugged into its own individual electrical which has a voltage rating that matched the rating plate.
 - This provides the best performance and also prevents overloading house wiring circuits, which could cause a fire hazard from overheated wires.
- If the wall socket is loose, do not insert the power plug.
 - There is a risk of electric shock or fire.
- Do not use a cord that shows cracks or abrasion damage along its length or at either end.
- Do not bend the power cord excessively or place heavy articles on it.
- Never unplug your refrigerator by pulling on the power cord. Always grip plug firmly and pull straight out from the outlet.
 - Damage to the cord may cause short-circuit, fire and/or electric shock.
- Do not use aerosols near the refrigerator.
 - Aerosols used near the refrigerator may cause an explosion or fire.



- This refrigerator must be properly installed and located in accordance with the manual before it is used.
- After unpacking, keep the packing materials out of reach of children.
 - There is a risk of death from suffocation if children put them over their head.
- Connect the power plug in proper position with the cord hanging down.
 - If you connect the power plug upside down, wire can get cut off and cause fire or electric shock.
- Make sure that the power plug is not squashed or damaged by the back of the refrigerator.
- When moving the refrigerator, be careful not to roll over or damage the power cord.
 - This constitutes a fire hazard.
- The appliance must be positioned so that the plug is accessible after installation.



- The refrigerator must be grounded.

safety information

- You must ground the refrigerator to prevent any power leakages or electric shocks caused by current leakage from the refrigerator.
 - Never use gas pipes, telephone lines or other potential lightening rods as ground.
 - Improper use of the ground plug can result in electric shock.
-



- If the power cord is damaged, have it replaced immediately by the manufacturer or its service agent.
 - The fuse on the refrigerator must be changed by a qualified technician or service company.
 - Failing to do so may result in electric shock or personal injury.
-



CAUTION

CAUTION SIGNS FOR INSTALLATION



- Allow sufficient space to install the refrigerator on a flat surface.
 - If your refrigerator is not level, the internal cooling system may not work correctly.
 - Keep ventilation opening in the appliance enclosure or mounting structure clear of obstruction.
 - Allow the appliance to stand for 2 hours after installation.
-



WARNING

SEVERE WARNING SIGNS FOR USING



- Do not insert the power plug with wet hands.
- Do not store articles on the top of the appliance.
 - When you open or close the door, the articles may fall and cause personal injury and/or material damage.
- Do not put items filled with water on the refrigerator.
 - If spilled, there is a risk of fire or electric shock.
- Do not let children hang on the door.
 - Failure to do so may cause serious personal injury.
- Do not leave the doors of the refrigerator open while the refrigerator is unattended and do not let children enter inside of the refrigerator.
 - There is a risk of children entrapment and serious personal injury because of low temperature.
- Do not insert your hands into the bottom area under the appliance.
 - Any sharp edges may cause personal injury.
- Do not let children step on drawer's cover.
 - It may break and cause slip hazard.
- Do not overfill the refrigerator with food.
 - When you open the door, an item may fall out and cause personal injury or material damage.
- Never put fingers or other objects into the dispenser hole.
 - Failure to do so may cause personal injury or material damage.
- Do not store volatile or flammable substances such as benzene, thinner, alcohol, ether or LP gas in the refrigerator.
 - The storage of any of such products may cause explosions.
- Do not store low temperature-sensitive pharmaceuticals products, scientific materials or other low temperature-sensitive products in the refrigerator.
 - Products that require strict temperature controls must not be stored in the refrigerator.
- Do not place or use electrical appliance inside the refrigerator, unless they are of a type recommended by the manufacturer.
- Do not use a hair dryer to dry the inside of the refrigerator. Do not place a lighted candle in the refrigerator for removing bad odors.
 - This may result in electric shock or fire.
- Do not touch the inside walls of the freezer or products stored in the freezer with wet hands.

safety information

- This may cause frostbite.
 - Do not use mechanical devices or any other means to accelerate the defrosting process, other than those recommended by the manufacturer.
 - Do not damage the refrigerant circuit.
-



- This product is intended only for the storage of food in a domestic environment.
 - Bottles should be stored tightly together so that they do not fall out.
 - If a gas leak is detected, avoid any naked flames or potential sources of ignition and air the room in which the appliance is standing for several minutes.
 - Use only the LED Lamps provided by manufacturer or service agents.
 - Children should be supervised to ensure that they do not play with and/or climb into the appliance.
 - Keep fingers out of “pinch point” areas : clearances between the doors and cabinet are necessarily small. Be careful when you open the doors when children are in the area.
-



- Do not disassemble or repair the refrigerator by yourself.
 - You run risk of causing a fire, malfunction and/or personal injury. In case of malfunction, please contact your service agents.
-



- Pull the power plug out of the socket before changing the interior lamps of the refrigerator.
 - Otherwise, there is a risk of electric shock.
-



- If the appliance generates a strange noise, a burning or smell or smoke, unplug the power plug immediately and contact your nearest service center.
 - Failing to do so may result in electric or fire hazards. Keep ventilation opening in the appliance enclosure or mounting structure clear of obstruction.
 - If you experience difficulty when changing the light, contact service agents.
 - If the products equipped with LED Lamp, do not disassemble Lamp Cover and LED Lamp by yourself.
 - Please contact your service agents.
 - If any dust or water is in refrigerator, pull out power plug and contact your Samsung Electronics service center.
 - There is a risk of fire.
 - This appliance is intended to be used in household and similar applications such as
 - staff kitchen areas in shops, offices and other working environments;
 - farm houses and by clients in hotels, motels and other residential type environments;
 - bed and breakfast type environments;
 - catering and similar non-retail applications.
-



There is protective film on the surface of some refrigerator models, which is used to protect the refrigerator from scratches during transport. To avoid static electricity, please peel off the protective film slowly. If the protective film is not removed for a long time, it may cause color shading of the steel plate.

safety information



CAUTION SIGNS FOR USING



- If the refrigerator is disconnected from the power supply, you should wait for at least five minutes before plugging it back in.
- If you will be away for more than three weeks or the refrigerator will not be used for a long period of time, you must empty and clean the refrigerator and pull out the power plug. Wipe excess moisture from the inside and leave the doors open.
 - Otherwise, odor and mold may develop.
 - Deterioration in the insulation may cause fire.
- If you have a long vacation or business trip and won't use water or ice dispensers, close the water valve.
 - Otherwise, water leakage may occur.
- To get best performance of product,
 - Do not place foods too closely in front of the vents at the rear of the appliance as it can obstruct free air circulation in the refrigerator compartment.
 - Wrap the food up properly or place it in airtight containers before put it into the refrigerator.
- Do not re-freeze frozen foods that have thawed completely.
- Do not place carbonated or fizzy drinks in the freezer compartment. Do not put bottles or glass containers in the freezer.
 - When the contents freeze, the glass may break and cause personal injury and property damage.
- Do not change the functionality of or modify the refrigerator.
 - Changes or modifications may result in personal injury and/or property damage. Any changes or modifications performed by a 3rd party on this completed appliance is neither covered under Samsung warranty service, nor is Samsung responsible for safety issues and damages that result from 3rd party modifications.
- Do not block air holes.
 - If the air holes are blocked, especially with a plastic bag, the refrigerator can be over cooled. If this cooling period lasts too long, the water filter may break and cause water leakage.
 - Do not put any newly introduced food for freezing near to already food.
- Please observe maximum storage times and expiry dates of frozen goods.
- Fill water tank, ice tray, water cubes only with potable water.
- Do not place food inside the refrigerator in a haphazard way.
 - The food will not cool properly.
- In case the model has Cool Select Zone, do not insert a shell to this rail, or the shelf can collide with beverage station cover and the beverage station cover can be broken.
- Use only the ice maker provided with the refrigerator.
- The water supply to this refrigerator must only be installed/connected by a suitably qualified person and connect to a potable water supply only.
- In order to operate the ice maker properly, water pressure of 138 ~ 862kpa(1.4~8.8kgf/cm²) is required.
- Do not apply strong shock or excessive force onto the surface of glass.
 - Broken glass may result in a personal injury and/or property damage.



- If the appliance is flooded, cut the power immediately and contact your nearest service center.



CAUTION SIGNS FOR CLEANING AND MAINTENANCE



- Do not directly spray water inside or outside the refrigerator.
 - There is a risk of fire or electric shock.
- Do not spray inflammable gas near the refrigerator.
 - There is a risk of explosion or fire.

safety information

- Do not spray cleaning products directly on the display.
 - Printed letters on the display may come off.
 - Remove any foreign matter or dust from the power plug pins. But do not use a wet or damp cloth when cleaning the plug, remove any foreign material or dust from the power plug pins.
 - Otherwise there is a risk of fire or electric shock.
 - Never put fingers or other objects into the dispenser hole and ice chute.
 - It may cause personal injury or material damage.
-



- Unplug the refrigerator before cleaning and performing maintenance.



WARNING

SEVERE WARNING SIGNS FOR DISPOSAL



- Ensure that none of the pipes on the back of the appliance are damaged prior to disposal.
- R600a or R134a is used as a refrigerant. Check the compressor label on the rear of the appliance or the rating label inside the refrigerator to see which refrigerant is used for your refrigerator. When this product contains flammable gas (Refrigerant R600a), contact your local authority in regard to safe disposal of this product. Cyclopentane is used as an insulation blowing gas. The gases in insulation material require special disposal procedure. Please contact your local authorities in regard to the environmentally safe disposal of this product. Ensure that none of the pipes on the back of the appliances are damaged prior to disposal. The pipes shall be broke in the open space.
- If the appliance contains iso-butane refrigerant (R600a), a natural gas with high environmental compatibility that is, however, also combustible. When transporting and installing the appliance, care should be taken to ensure that no parts of the refrigerating circuit are damaged.
- When disposing of this product or other refrigerators, remove the door/door seals, door latch so that small children or animals cannot become trapped inside. Leave the shelves in place so that children may not easily climb inside. Children should be supervised to ensure that they do not play with the old appliance.
- Please dispose of the packaging material for this product in an environmentally friendly manner.



ADDITIONAL TIPS FOR PROPER USAGE

- In the event of a power failure, call the local office of your Electricity Company and ask how long it is going to last.
 - Most power failures that are corrected within an hour or two will not affect your refrigerator temperatures. However, you should minimize the number of door openings while the power is off.
 - Should the power failure last more than 24 hours, remove all frozen food.
 - If keys are provided with the refrigerator, the keys should be kept out of the reach of children and not in vicinity of the appliance.
 - The appliance might not operate consistently (possibility of temperature becoming too warm in refrigerator) when sited for an extended period of time below the cold end of the range of temperature for which the refrigerating appliance is designed.
 - Do not store food which spoils easily at low temperature, such as bananas, melons.
 - Your appliance is frost free, which means there is no need to manually defrost your appliance, as this will be carried out automatically.
 - Temperature rising during the defrost can comply with ISO requirement. But if you want to prevent an undue rise in the temperature of the frozen food while defrosting the appliance, please wrap the frozen food in several layers of newspaper.
 - Any increase in temperature of frozen food during defrosting can shorten its storage life.
 - This appliance is intended to be used in household and similar applications such as
 - Staff kitchen areas in shops, offices and other working environments;
 - Farm houses and by clients in hotels, motels and other residential type environments;
 - Bed and breakfast type environments;
 - Catering and similar non-retail applications.
-

contents

SETTING UP YOUR REFRIGERATOR

10

- 10 Getting ready to install the refrigerator
- 11 Installation of the water line (Auto Ice Maker Model)
- 14 Setting up the refrigerator
- 14 Removing the refrigerator doors
- 23 Adjusting the doors
- 24 making minor adjustments between doors

OPERATING YOUR SAMSUNG REFRIGERATOR

25

- 25 Parts and features
- 26 Using the control panel
- 27 Controlling the temperature
- 29 Making Ice
- 30 Storing food in the refrigerator
- 30 Storing food in the freezer drawer
- 31 Removing and relocating the fridge accessories
- 32 Removing the freezer accessories
- 33 Using the water dispenser (option)
- 34 Cleaning the refrigerator
- 35 Replacing the interior light

TROUBLESHOOTING

36

setting up your refrigerator

GETTING READY TO INSTALL THE REFRIGERATOR

Congratulations on your purchase of this Samsung Refrigerator. We hope you enjoy the state-of-art features and efficiencies that this new appliance offers.

Selecting the best location for the Refrigerator

- A location with easy access to the water supply.
- A location without direct exposure to sunlight.
- A location with level (or nearly level) flooring.
- A location with enough space for the Refrigerator doors to open easily.
- Allow sufficient space to the right, left, back and top for air circulation. If the Refrigerator does not have enough space, the internal cooling system may not work properly.
- Please ensure that appliance can be moved freely in the event of maintenance & service.

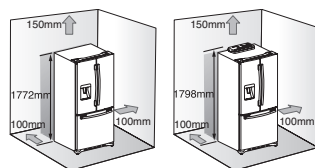

First thing! Make sure that you can easily move your Refrigerator to its final location by measuring doorways (both width and height), thresholds, ceilings, stairways, etc.

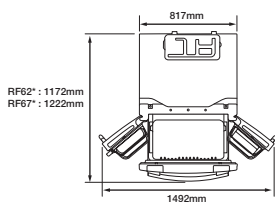

Drawer-Type

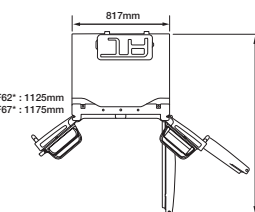
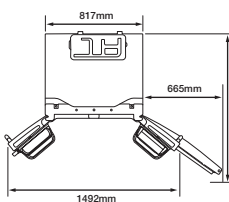

Swing-Type



- Allow clearance to the right, left, back and top when installing. This will help reduce power consumption and keep your energy bills lower.
- If you install the Refrigerator where is below 10°C, it may not function in optimum level.
- Do not locate the refrigerator where the wet condition.

When moving your refrigerator



To prevent floor damage be sure the front leveling legs are in the up position (above the floor). Refer to 'Adjusting the doors' in the manual (on page 23)

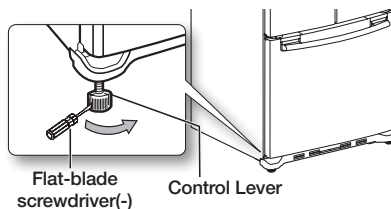

Flat-blade screwdriver(-) Control Lever

FLOORING

For proper installation, this refrigerator must be placed on a level surface of hard material that is the same height as the rest of the flooring. This surface should be strong enough to support a fully loaded refrigerator, or approximately 106kg. To protect the finish of the flooring, cut a large section of the cardboard carton and place under the refrigerator where you are working. When moving the refrigerator, be sure to pull it straight out and return it to position by pushing it straight in.

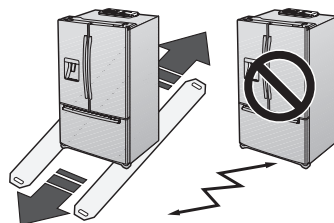

setting up your refrigerator

INSTALLATION OF THE WATER LINE (AUTO ICE MAKER MODEL)

Before you install the water line

- The water line installation is not warranted by the refrigerator manufacturer. So before you install the water line, read the whole steps for installing and follow these instructions carefully to minimize the risk of expensive water damage.
- Banging pipes (water banging in the pipes) in house plumbing can cause damage to fridge parts and lead to water leakage or flooding. Call a qualified plumber to correct the problem before installing the water supply line to the fridge.
- To prevent burns and product damage, do not hook up the water line to the hot water line.
- Do not install the water line in areas where temperatures fall below freezing.
- When using any electrical device (such as a power drill) during installation, be sure the device is insulated or wired in a manner to prevent electric shock.
- All installations must be in accordance with local plumbing code requirements.
- Water line Kit and water filter are not covered by Samsung's Warranty. The manufacturer (or dealer, installer) of them is responsible for any defects and all the loss caused by water filter & water line kit.
- The filter should be replaced according to manufacturer (or dealer)'s instruction.
- To order additional water filters, please contact the manufacturer (or dealer) of the filter.



Check the accessories listed below.



Water line fixer and screws



Pipe connector



Water line



Fastner

- Refer to 'MAKING MINOR ADJUSTMENTS BETWEEN DOORS' (on page 24)

USING THE WATER FILTER (NOT PROVIDED)

Connecting to water supply line

- Shut off the main water supply line and turn the Ice maker to the off position.
- Locate the nearest cold drinking water line.
- Follow the instructions in the water filter installation kit.
- After connecting the water supply line to the Cartridge Holder inlet and installing the Filter Cartridge (insert plastic line in fully).
- Turn on water supply and flush 3L into a bucket to clear the water filter.
- The water filter must be installed outside the refrigerator. It is not provided with your new refrigerator. The filter cartridge (8) and holder (9) kit can be purchased from the retailer where you purchased this refrigerator.
- Do not use copper line.
- Cut the tubing, making sure the ends are square and clean.



1. Cold Water line
2. Pipe Clamp.
3. Plastic line
4. Compression Nut
5. Compression Sleeve
6. Packing Nut
7. Shut Off Valve
8. Filter Cartridge
9. Cartridge Holder

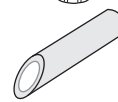
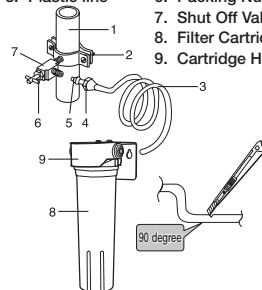

Incorrect

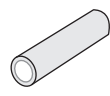

Correct

Connect the water line to the fridge

- Connect the plastic line on the back of your fridge to the cartridge holder outlet (fully insert the plastic line to the cartridge holder outlet).
- Insert plastic clip to the cartridge holder inlet and outlet.
- Turn water on and check for any leakage.



- You can purchase the necessary filter cartridge at the retailer where you purchased this refrigerator. Make sure you buy the SAMSUNG filter cartridge (Replacement cartridge No : DA29-10105J) to ensure the best performance.
- Water line must be connected to drinkable water only
- A compression fitting and nut kit is supplied with the unit and it is inside the fridge drawer.
- When pushing the Refrigerator back, make sure you don't roll over the power cord or water line (Icemaker supply line)

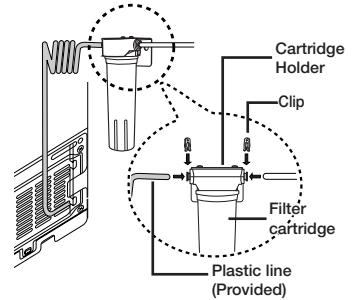

TO USE WITHOUT THE WATER FILTER SECTION

Connecting to the water supply line

- Shut off the main water supply line and turn the Ice maker to the off position.
- Locate the nearest cold water drinking line.

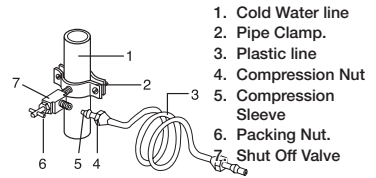

1. Cold Water line
2. Pipe Clamp.
3. Plastic line
4. Compression Nut
5. Compression Sleeve
6. Packing Nut.
7. Shut Off Valve

1. First, shut off the main water supply line.
2. Locate the nearest cold, drinking water line.
3. Follow the Water line Installation Instructions in the installation kit.

CAUTION

The water line must be connected to the cold water pipe. If it is connected to the hot water pipe, it may cause the purifier to malfunction.

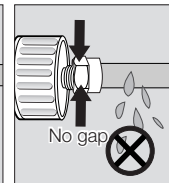
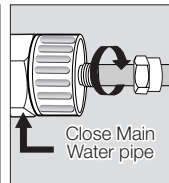
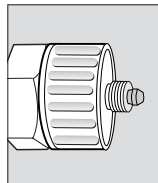
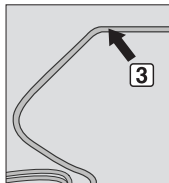
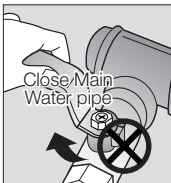

setting up your refrigerator

Connecting the water line to the refrigerator

1. Remove the cap from water line on the unit and insert compression nut to the water line on the unit after disassembling from provided water line.
2. Connect both water line from the unit and water line in the kit.
3. Tighten the compression nut onto the compression fitting. There should be no gaps between (A, B & C)
4. Turn water on and check for any leakage.

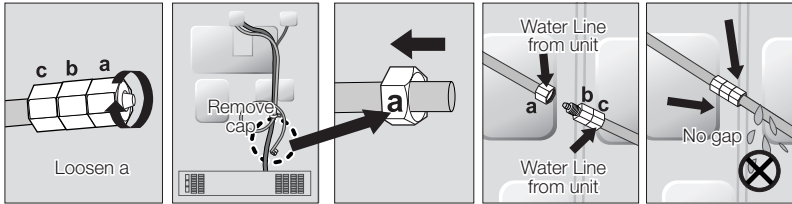

Only connect the water line to a drinkable water source.

If you have to repair or disassemble the water line, cut off 6.5mm of the plastic tubing to make sure you get a snug, leak-free connection.



After the water supply has been installed check all the joints to ensure there are no leaks.

- Samsung Warranty does not cover THE WATER LINE INSTALLATION.
- The cost of the water line installation is at the customers expense, unless the retailer has covered this expense in the delivery charge.
- Please contact a Plumber or Authorized Installer for the installation if needed.
- If Water leakage occurs due to improper installation, Please contact installer.

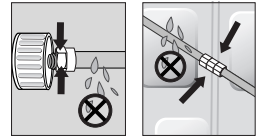

SETTING UP THE REFRIGERATOR

Now that you have your new Refrigerator installed in place, you are ready to set up and enjoy the features and functions of the appliance. By completing the following steps, your Refrigerator should be fully operational.

1. Place the Refrigerator in an appropriate location with reasonable clearance between the wall and the Refrigerator. Refer to installation instructions in this manual. (P8. Selecting the best location for the Refrigerator)
2. Once the Refrigerator is plugged in, make sure the interior light comes on when you open the doors.
3. Set the Temperature control to the coldest temperature and wait for an hour. The Freezer will get slightly chilled and the motor will run smoothly.
4. After powering the Refrigerator, it will take a few hours to reach the appropriate temperature. You can store food and drinks in the Refrigerator after the temperature is sufficiently cool.

Required Tools (Not provided)



Phillips Head Driver(+)



Flat Head Driver(-)

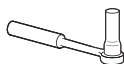

Socket Wrench
(10mm) (for bolts)



Hex Wrench (Ø5mm)
(for Mid hinge)



Hex wrench
(5/32 inch)
(for Mid hinge shaft)

REMOVING THE REFRIGERATOR DOORS

Some installations require door/drawer removal to transport the Refrigerator to its final location.

Do not remove the door/drawer if it is not needed. Before removing the door/drawer make sure you read following items.



WARNING

Disconnect power to the Refrigerator before removing the door or drawer.



- Be careful not to drop, damage or scratch the door/drawer while removing them.
- Be careful not to get injured while removing the door/drawer.
- Reattach the door/drawer properly to avoid:
 - Moisture from air leakage.
 - Uneven door alignment.
 - Wasting energy due to improper door seal.

setting up your refrigerator

DISASSEMBLING THE FRIDGE DOOR



Be careful not to drop and scratch the fridge door while removing the fridge door!

WARNING

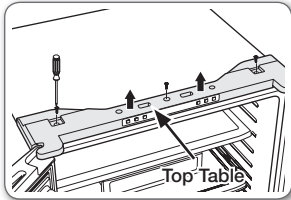

1. Remove the 3 screws holding down the top table and remove it.

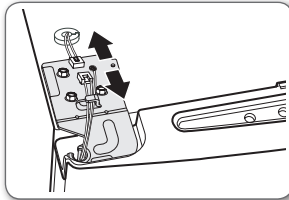

2. Disconnect electric wire on the top of the refrigerator.

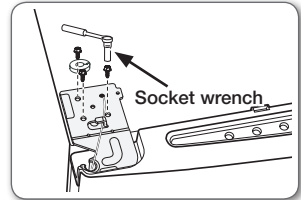

3. Remove the 3 hex bolts that hold the hinge on the top of the refrigerator with the 10mm socket wrench.

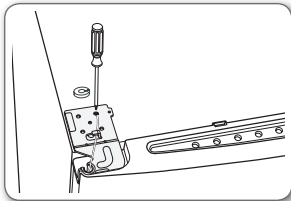

4. Remove the screw that holds the ground wire with a philips screwdriver(+).

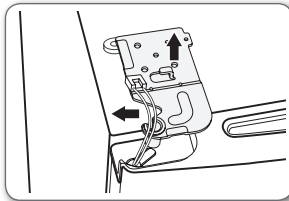

5. Separate the hinge from the electric wire and ground wire as shown above.

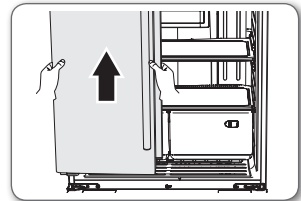

6. Lift the door straight up to remove. Be careful not to drop and scratch the doors while removing them.

DISASSEMBLING THE FREEZER DOOR (DRAWER TYPE)

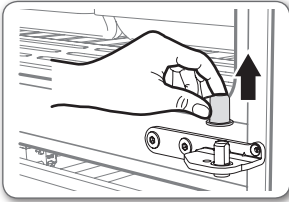

1. Separate the cap on the middle hinge.

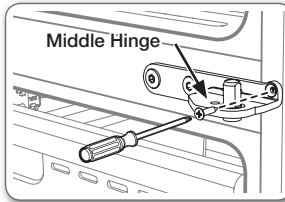

2. Remove the screw attached to the left and right middle hinges with a philips screwdriver(+). Remove the 2 hex head bolts attached to the left and right middle hinges with an allen wrench(\varnothing 5mm).

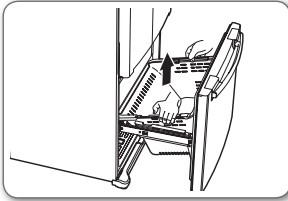
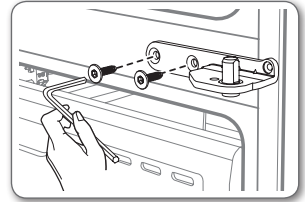

3. After opening the Freezer door, lift the drawer box.

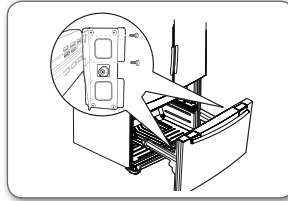

4. Remove 4 hex head bolts from both sides with a socket wrench(10mm)

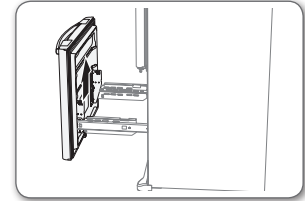

5. Lift up the freezer door from the rails. Be careful not to drop and scratch the freezer door.

DISASSEMBLING THE FREEZER DOOR (SWING TYPE)

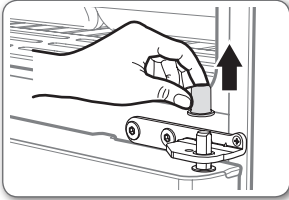

1. Separate the Cap on the Middle Hinge.

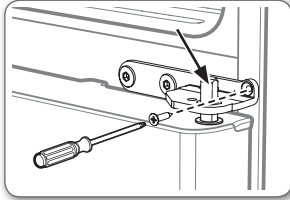

2. Remove the screw attached to the left and right middle hinges with a philips screwdriver(+). Remove the 2 hex head bolts attached to the left and right middle hinges with an allen wrench(Ø5mm).

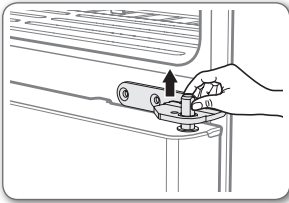
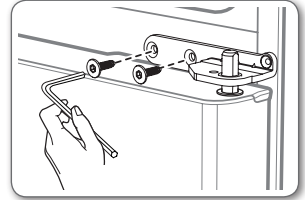

3. Remove the Middle Hinge connected to the Freezer.

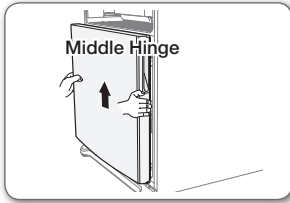

4. Lift up the freezer door from the hinge. Be careful not to drop and scratch the freezer door.

setting up your refrigerator

REASSEMBLING THE FRIDGE DOOR

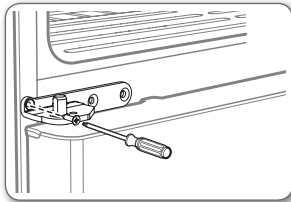

1. Insert and tighten the screw into the left and right middle hinges with a philips screwdriver(+).

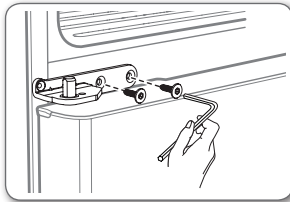

2. Insert and tighten the 2 hex head bolts into the left and right middle hinges with an allen wrench(Ø5mm).

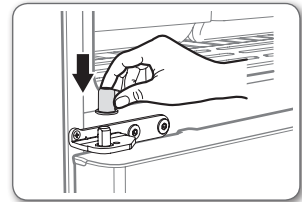

3. Replace the middle hinge cap.

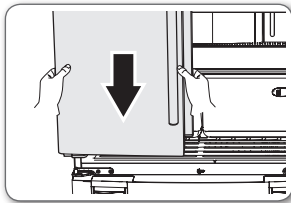

4. Place the hole in the bottom of the left door over the middle hinge.

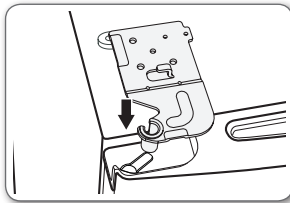

5. Insert the left upper hinge shaft into the hole on the corner of the fridge door.

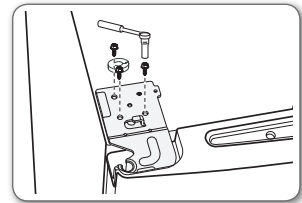

6. Insert the upper hinges into the holes at the top of the door. Insert and tighten the 3 hex head bolts into the left and right upper hinges with a socket wrench(10mm).

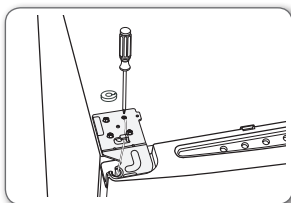

7. Insert and tighten the ground screw into the left and right upper hinges with a philips screwdriver(+).

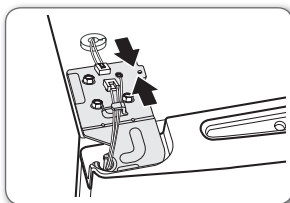

8. Connect the electronic wire on the top of the refrigerator.

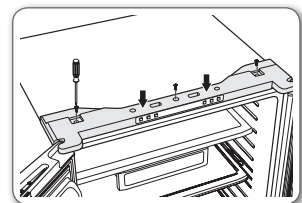

9. Position the top table in place. Insert and tighten the 3 screws into the top table with a philips screwdriver(+).

REASSEMBLING THE FREEZER DOOR (DRAWER TYPE)

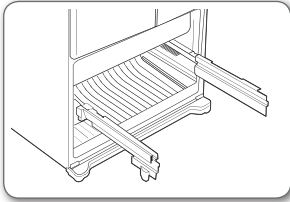

1. Pull out the rails to the full length on each side of the cabinet evenly.

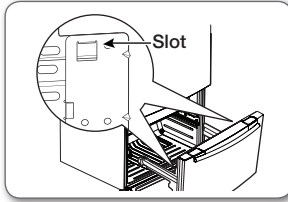

2. Hang the freezer door front onto open slot on the sides.

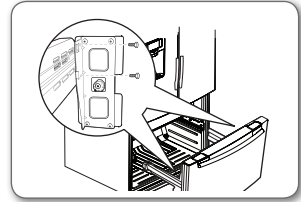

3. With the 10mm wrench, reattach 4 bolts to connect the rail with the door.

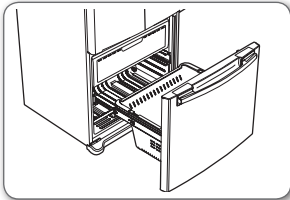

4. Replace the drawer box.

REASSEMBLING THE FREEZER DOOR (SWING TYPE)

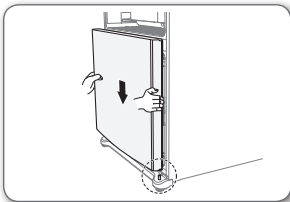

1. Place the hole in the bottom of the freezer door over the right side low hinge.

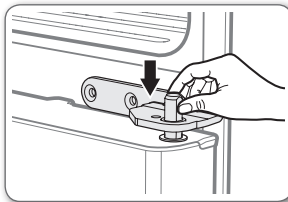

2. Replace the middle hinge connected to the freezer.
3. Insert and tighten the screw into the left and right middle hinges with a philips screwdriver(+). Insert and tighten the 2 hex head bolts into the left and right middle hinges with an allen wrench(Ø5mm).
4. Replace the cap on the middle hinge.

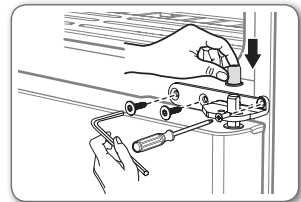

setting up your refrigerator

HOW TO REVERSE THE DOOR (OPTION)

Unplug the refrigerator or disconnect the power.

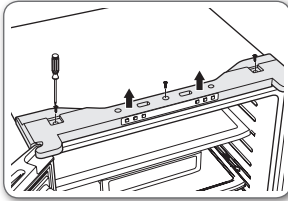

1. Remove 3 screws on the hinge cover.
2. Disassemble the hinge cover.

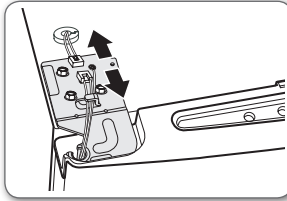

3. Disassemble 2 connectors. (a housing and a reed switch)

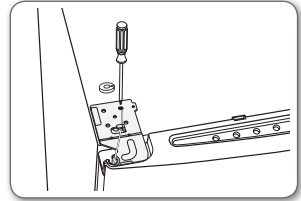

4. Disassemble ground wire by removing 1 screw on each side.

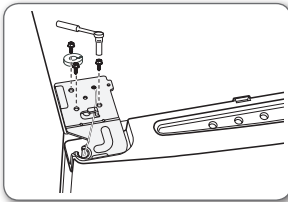

5. Disassemble the upper hinge by removing 3 bolts on each side with the 10mm wrench.
 1. Avoid the wire damage.
 2. Fridge door is possible to tip over at this time.

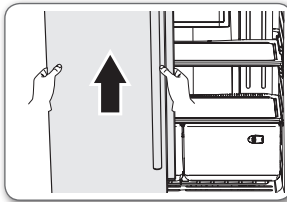

6. Remove each fridge doors by lifting it up.
 1. Possible to drop or scratch the door at this time.
 2. Middle hinge cap may come off with the door.

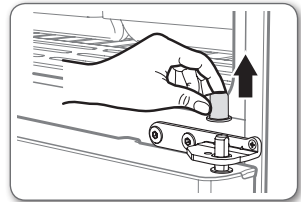

7. Disassemble middle hinge cap.

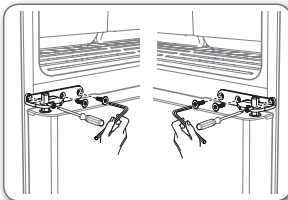

8. Remove 1 screw and 2 bolts of each side (use Ø5mm allen wrench).
 1. At first, Remove left side middle hinge and right side.
 2. Be careful not to drop the freezer door.

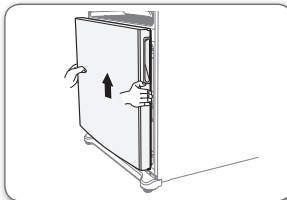

9. Remove the freezer door by lifting it up.
 1. Possible to drop or scratch the door at this time.
 2. Low hinge cap may come off with the door.

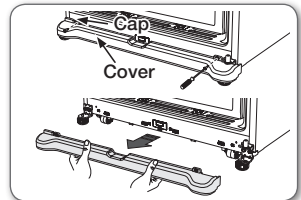

10. Remove 2 screws.
11. Separate front leg Cover.

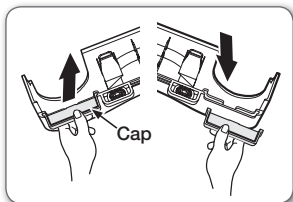

- 12.** Separate the Cap of the front leg Cover. (pull out inside of Cap)
- 13.** Insert the Cap on the other side of the front leg Cover.

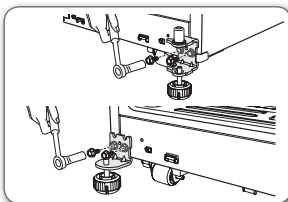

- 14.** Remove 2 bolts of each hinge with the 10mm wrench.
- 15.** Place them in front of each side.

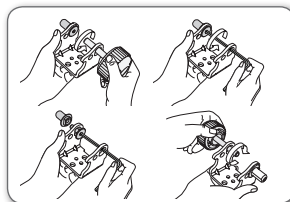

- 16.** Separate low hinge shaft by using 5/32" wrench and disassemble low hinge leg by turning it colockwise, and then assemble the low hinge by turning it over.

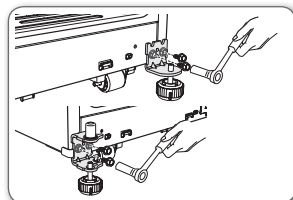

- 17.** Reattach the former right hinge on the left side and the former left hinge on the right side by using 2bolts.

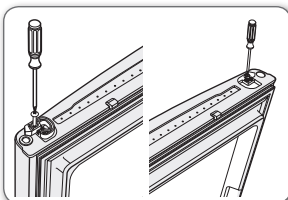

- 18.** Separate stopper by removing 1 screw on the right lower side of freezer stopper and assemble the stopper on the left side by reversing it.

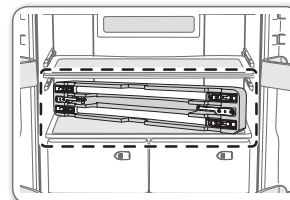

- 19.** The middle hinge for reversing a door can be found in the fridge.

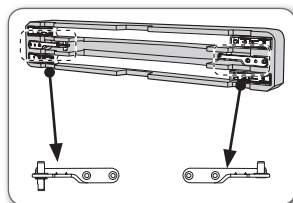

- 20.** Change the middle hinges assembled at refrigerator to the middle hinges in the fridge with handles.

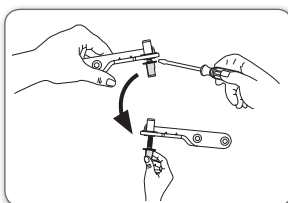

- 21.** Use the black hinge cap of the middle hinge assembled at refrigerator. Then place it at the bottom of the left middle hinge supplied separately.
Use the Flat-blade screwdriver(-).

setting up your refrigerator

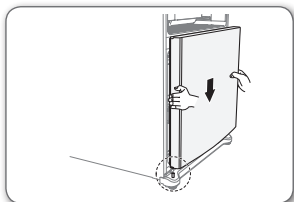

- 22.** Place the hole in the bottom of the freezer door over the low hinge.

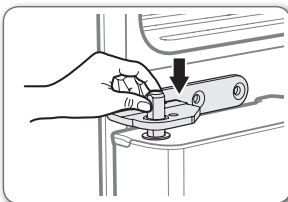

- 23.** Replace the middle hinge connected to the freezer.
24. Insert and tighten the screw into the left and right middle hinges with a philips screwdriver(+). Insert and tighten the 2 hex head bolts into the left and right middle hinges with an allen wrench(Ø5mm).
25. Replace the cap on the middle hinge.

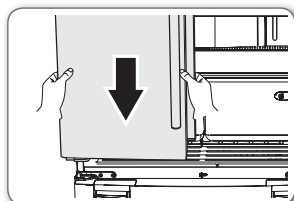
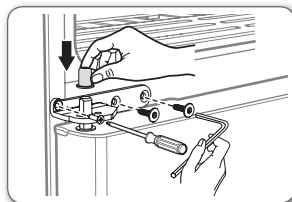

- 26.** Place the hole in the bottom of the left door over the middle hinge.

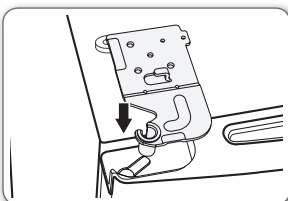

- 27.** Insert the left upper hinge shaft into the hole on the corner of the fridge door.

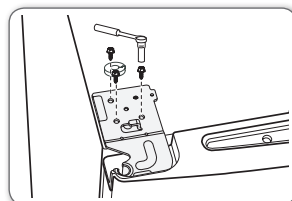

- 28.** Insert the upper hinges into the holes at the top of the door. Insert and tighten the 3 hex head bolts into the left and right upper hinges with a socket wrench(10mm).

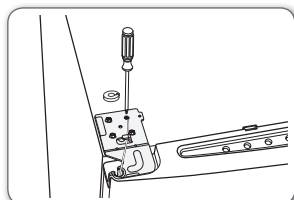

- 29.** Insert and tighten the ground screw into the left and right upper hinges with a philips screwdriver(+).

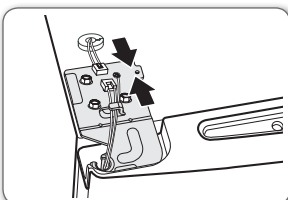

- 30.** Connect the electronic wire on the top of the refrigerator.

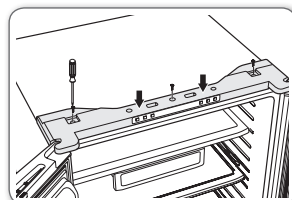

- 31.** Position the top table in place. Insert and tighten the 3 screws into the top table with a philips screwdriver(+).

setting up your refrigerator

ADJUSTING THE DOORS

After putting the doors back on the Refrigerator, make sure the Refrigerator is level so that you can make final adjustments.

If the Refrigerator is not level, it will not be possible to get the doors perfectly even.

Also it is possible to sweat in the refrigerator and ask more energy bills.

For example, when the left side is lower than the right side, insert a flat-blade screwdriver into a notch on the left control lever, and turn it clockwise or counter clockwise to level the door.

Turning it clockwise to raise the refrigerator and counterclockwise to lower it.

For the left side is higher, do it with right lever.

WARNING  Both control levers must be surely touching the floor to avoid the possible personal injury or property damage because of tipping.

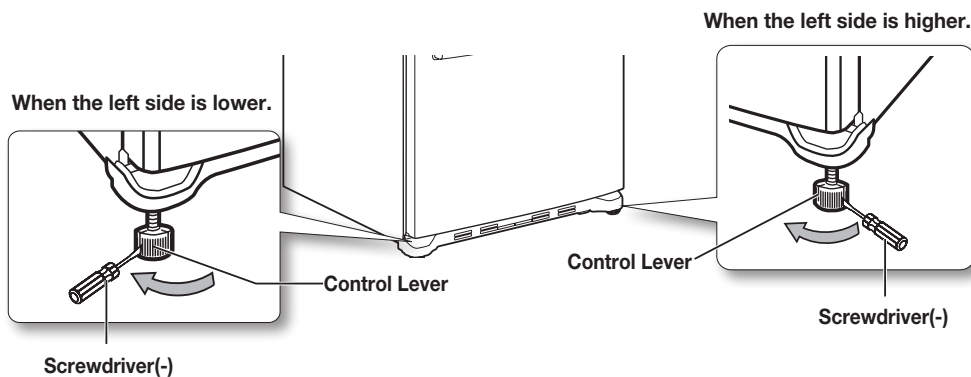

setting up your refrigerator

MAKING MINOR ADJUSTMENTS BETWEEN DOORS

Remember, a level Refrigerator is necessary for getting the doors perfectly even. If you need help, review the previous section on leveling the Refrigerator.

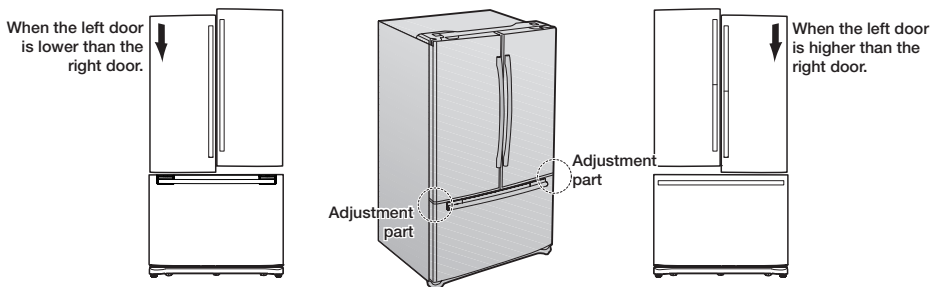

1. Pull out the freezer drawer (**1**), then you can see the middle hinge (**2**).
2. Insert the hex wrench (4 mm) (**3**) into the shaft (**4**) of the middle hinge.
3. Please adjust the height by turning the hex wrench (**3**) clockwise (↻) or counter-clockwise (↻).

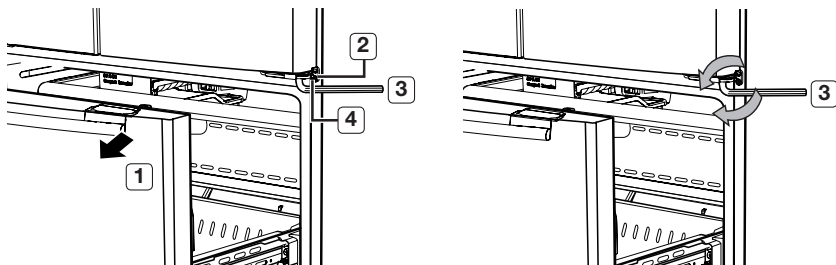

When you turn the hex wrench counter-clockwise (↻), the door will move up. Only the left-door height is adjustable for Swing-Type.

1. After adjusting the doors, please insert the supplied fastener (**5**) using Pliers (**6**) in the gap between the hinge-grommet (**7**) and the middle hinge (**8**). The number of fasteners you'll need to insert depends on the gap.

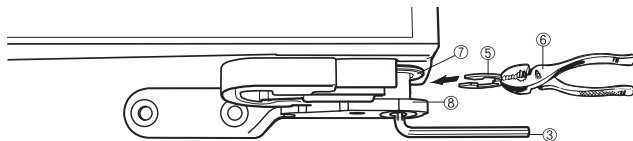

2 fastener are enclosed with the refrigerator. The thickness of each fastener is 1.0mm.

operating your samsung refrigerator

PARTS AND FEATURES

Use this page to become more familiar with the parts and features of the Refrigerator.

Fridge

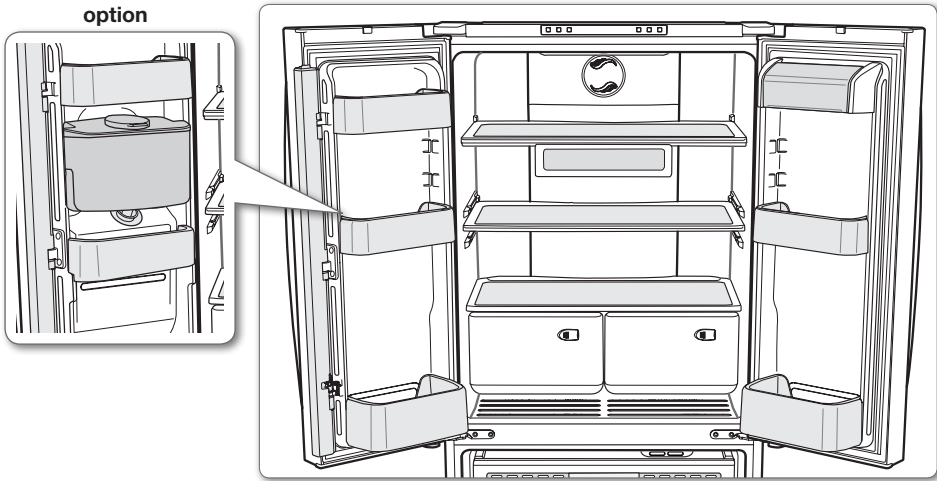

Freezer

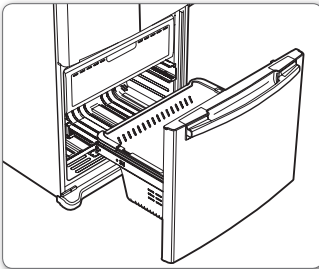

Drawer Type

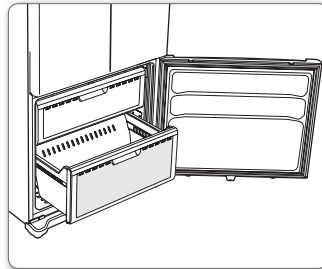

Swing Type

USING THE CONTROL PANEL

1. For auto ice maker model

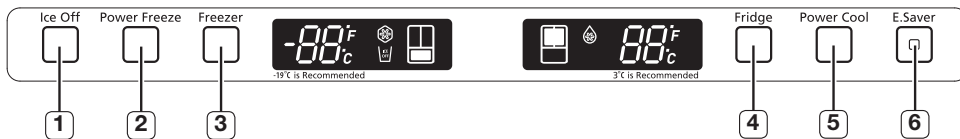

2. For normal ice maker model

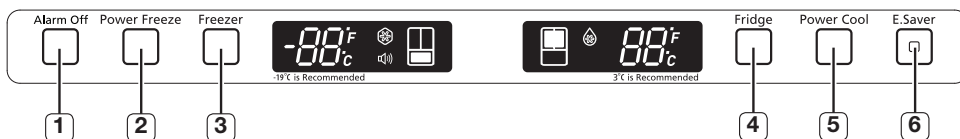

Temperature & Function select / control panel

(1) Ice Off Button (Option)	When the Ice Off button is pressed, ice will not be produced. Use this function only when it is needed.
(1) Alarm Off Button (Option)	When the Alarm Off Button is pressed, alarm will not sound in case of door open. Use this button only when it is needed.
(2) Power Freeze Button	Press this button to freeze food quickly. (Power Freeze will last 72 hours.)
(3) Freezer Button	Freezer temperature set button. Press this button to set the Freezer temp between -14°C and -25°C. (At initial power on, the default setting is -19°C.)
(4) Fridge Button	Fridge temperature set button. Press this button to set the Fridge temperature in 1°C intervals between 7°C and 1°C. (At initial power on, the default setting is 3°C.)
(5) Power Cool Button	Press this button to cool the food in the fridge quickly. (Power Cool will shut off when -4°C is reached or after 2 and a half hours.)
(6) E.Saver Button	Press the Energy Saver button for better energy efficiency. If water drops appear on the doors, turn the Energy Saver function off.

operating your samsung refrigerator

CONTROLLING THE TEMPERATURE



SETTING THE FREEZER TEMPERATURE

If you want to control the freezer temperature, follow as below.
Press the Freezer Button (Refer the picture)

- The temperature can be set in 1°C interval between -25°C and -14°C.

When selecting the temperature, the set temperature is displayed initially for 5 seconds, then the actual temperature is displayed.

(There may be slight difference between the set temperature and displayed actual temperature, but it will be corrected to the set temperature automatically.)

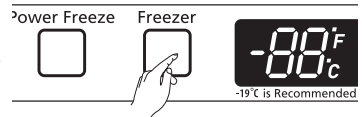

- The Freezer temperature will change depending on the number of door openings, quantity of food, ambient temperature, etc.
- The temperature display will blink when freezer temperature increases due to frequent door opening, keeping warm food, etc.

(Blinking will stop when the refrigerator reaches normal temperature. If for some reason it does not stop after a long period of time, contact a Samsung service center.)

SETTING THE FRIDGE TEMPERATURE

If you want to control the fridge temperature, follow as below.
Press the Fridge Button (Refer the picture)

- The temperature can be set in 1°C interval between 1°C and 7°C.

When selecting the fridge temperature, the set temperature is displayed initially for 5 seconds, then the actual temperature is displayed.

(There may be slight difference between the set temperature and displayed actual temperature, but it will be corrected to the set temperature automatically.)

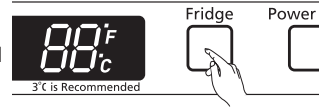

- The Fridge temperature will change depending on the number of door openings, quantity of food, ambient temperature, etc.
- Temperature of each shelf or container in the fridge may be different.
- The temperature display will blink when fridge temperature is increases due to frequent door opening, keeping warm food, etc.

(Blinking will stop when the refrigerator reaches normal temperature. If for some reason it does not stop after a long period of time, contact a Samsung service center.)

IF YOU WANT TO MAKE ICE FASTER (CONTROLLING THE POWER FREEZE)

Press the Power Freeze Button. (Refer to the picture.)

- The power Freeze light on the display goes on (see the arrow mark) and this function begins to operate regardless of the set freezer temperature.

Press the Power Freeze Button again to cancel this function.

- The light goes off and it operates at the set freezer temperature again.
- The Power Freeze function operates for 72 hours regardless of the set temperature.

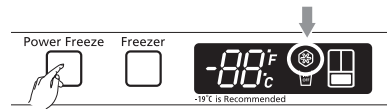

This function must be activated before putting large stuff in freezer compartment at least 24 hours before.

IF YOU WANT TO SPEED UP THE COOLING IN THE FRIDGE (POWER COOL)

Press the Power Cool Button. (Refer to the picture.)

- The Power cool light on the display goes on (see the arrow mark) and this function begins to operate regardless of the set fridge temperature.

Press the Power Cool Button again to cancel this function.

- The light goes off and it operates at the set fridge temperature again.



The Power Cool function operates for 2 and a half hours regardless of the set temperature.

operating your samsung refrigerator

MAKING ICE

AUTO ICE MAKER MODEL

The ice maker will produce 8 cubes per cycle - approximately 100~130 cubes in a 24-hour period, depending on freezer compartment temperature, room temperature, number of door openings and other use conditions.

Throw away the first few batches of ice to allow the water line to clear.

Be sure nothing interferes with the sweep of the feeler arm.

When the bin fills to the level of the feeler arm, the icemaker will stop producing ice.

After the icemaker has been turned on again, there will be a time delay before the icemaker resumes operation.

It is normal for several cubes to be joined together.

If ice is not used frequently, old ice cubes will become cloudy, taste stale and shrink.

So if you don't want to make ice, press the Ice Off button.

-  When "Ice making" function is selected, ice-making is priority. Then the temperature of freezer will be lower than the setting temperature. If you don't need the "Ice making" function, please press the button of "Ice Off".

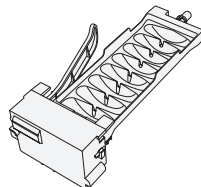

TWIST ICE MAKER MODEL

1. Pull out the Ice-cube trays.
2. Fill trays up to the water level mark (arrow).
3. Put the Ice-cube trays back in position. And close the freezer door.

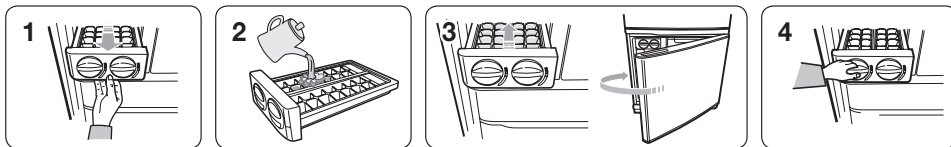

4. Once the water has become frozen, turn the dials on the Ice cube trays to empty Ice cubes into the storage bin.

Saving Energy Tips

- Install the appliance in a cool, dry room with adequate ventilation. Ensure that it is not exposed to direct sunlight and never put it near a direct source of heat (radiator, for example).
- Never block any vents or grilles on the appliance.
- Allow warm food to cool down before placing it in the appliance.
- Put frozen food in the refrigerator to thaw. You can then use the low temperatures of the frozen products to cool food in the refrigerator.
- Do not keep the door of the appliance open for too long when putting food in or taking food out. The shorter time for which the door is open, the less ice will form in the freezer.
- Clean the rear of the refrigerator regularly. Dust increases energy consumption.
- Do not set temperature colder than necessary.
- Ensure sufficient air exhaust at the refrigerator base and at the back wall of the refrigerator. Do not cover air vent openings.
- Allow clearance to the right, left, back and top when installing. This will help reduce power consumption and keep your energy bills lower.

STORING FOOD IN THE REFRIGERATOR

The Samsung Refrigerator has been designed to provide you with maximum space saving features and functions. Here are some of the customized compartments we have created to keep your food fresher longer. In order to further prevent odor from seeping into the ice compartment, stored food should be wrapped securely and as airtight as possible.

Moving Tray

Can be used to store small dairy items like butter or margarine, yogurt or cream cheese bricks



Bottle Bin

Designed to handle large, bulky items such as gallons of milk or other large bottles and containers.



Fridge Shelves

Designed to be crack-resistant, the shelves can be used to store all types of food and drinks. Circular marks on the glass surface are a normal phenomenon and can usually be wiped clean with a damp cloth.



Vegetable & Fruit Drawers

Used for preserving the freshness of your stored vegetables and fruits. This drawer has been specifically designed to control the level of humidity within the compartment. Keep vegetables and fruits separate when possible.



Do not place any large articles of food under the lamp in the Refrigerator. An air sensor is located near the lamp and if the sensor is blocked, your Refrigerator may become too cold. Please place Vegetable and Fruits in the Vegetable and Fruits Drawers to avoid freezing them. If the food in your Refrigerator becomes frozen, please set the temperature higher.



Bottles should be stored tightly together so that they do not tip and fall out when the Refrigerator door is opened.

STORING FOOD IN THE FREEZER DRAWER

Pull Out Drawer

Best used to store meats or dry foods. Stored food should be placed in a container or wrapped securely using plastic wrap or other suitable wrapping materials.



Freezer Drawer Bin

Can be used to store meat and dry foods. Stored food should be placed in a container or wrapped securely using plastic wrap or other suitable wrapping materials.



If you plan to go away for a long time, empty the Refrigerator and turn it off. Wipe the excess moisture from the inside of the appliance and leave the doors open. This helps keep odor and mold from developing.

operating your samsung refrigerator

REMOVING AND RELOCATING THE FRIDGE ACCESSORIES

1. Door Bins

To remove - Simply lift the bin up and pull straight out.

To replace - Slide it in above the desired location and push down until it stops.

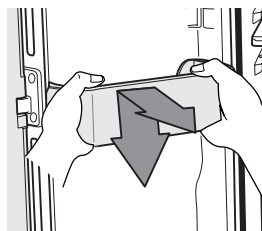

Injury may occur if the door bins are not firmly inserted. Do not allow children to play with bins. Sharp corners of the bins may cause injury.



Empty the bin before adjusting it.

Dust removal method -Remove the guard and wash in water.

2. Fridge shelves

To remove - When pulling out the shelf, if it does not slide out easily, lift it up slightly and pull out again.

To replace - When pushing in the shelf, if it does not slide in easily, lift it up slightly and push in again.

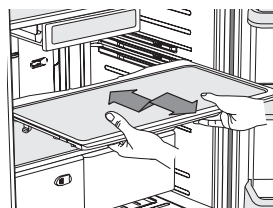

The Glass shelves are heavy. Use special care when removing them.

3. Vegetable & Fruit Drawers

To remove - Pull the drawer out to full extension. Tilt up the front of the drawer and pull straight out.

To replace - Insert the drawer into the frame rails and push back into place.

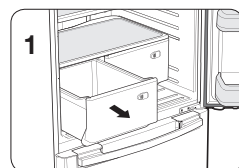

The drawers need to be removed before the glass shelf above them can be lifted out.



To get the best energy efficiency of this product, please leave all selves, drawers and baskets on their original position like as illustration in page 25

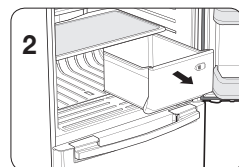

REMOVING THE FREEZER ACCESSORIES

1. Pull Out Drawer

To remove - Pull the drawer out to full extension. Tilt up rear of drawer and lift straight out.
(Refer to picture 1 & 2)

Open the freezer door fully and remove the drawer.

To replace - Place the drawer onto the rails by tilting it up. Lower the drawer into place until it is horizontal and slide the drawer in.
(Refer to picture 3)

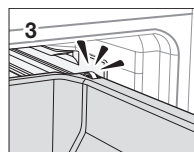
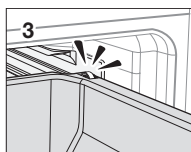
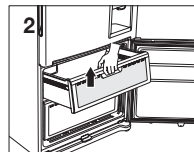
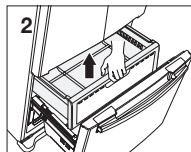
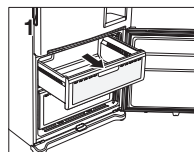
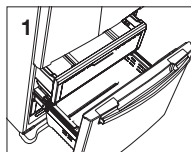

2. Freezer Drawer Bin

Swing-Type

To remove - Pull the drawer out fully. Tilt up the rear of the bin and lift it out to remove.

To replace - Place the bin into the rail assembly.

When replacing, place the drawer bin holder into the hole of the rail

Drawer-Type

To remove the drawer - Pull the drawer out fully. Tilt up the rear of the bin and lift it out to remove.

To relocate the drawer - Place the bin into the rail assembly.

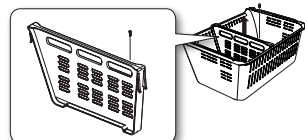
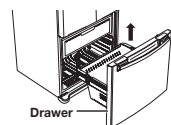
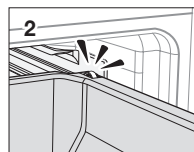
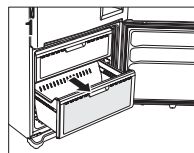

(RF67****)



Do not allow children to play with the refrigerator, as they could injure themselves or damage the refrigerator.

Do not sit on the Freezer door. The door may break. Do not allow children to climb into the Freezer basket.



If you remove the divider to clean the basket bin, you must reinstall the divider using 1 screw after cleaning to prevent children from getting trapped inside the basket.

operating your samsung refrigerator

USING THE WATER DISPENSER (OPTION)

You can easily obtain chilled water with the water dispenser without opening the refrigerator door. In addition, you can save electricity by reducing the number of times the door is opened by more than 30%.

Overview

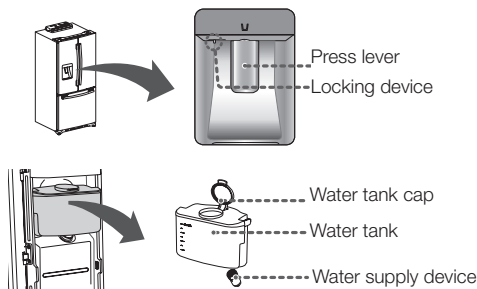

Filling the water tank

You can fill the water with the water tank sitting inside of the refrigerator or you can remove the water tank to fill the water.

Method 1

After opening the cap, Fill the water.
If you pour the water too fast, water may overflow.



Method 2

1. Release the lock on the both side of the water tank to remove the lid on the water tank.
2. Fill the water in the water tank.

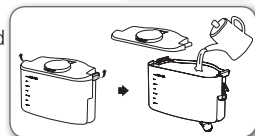

Do not put anything other than water in the water tank.

- Do not put anything other than water in the water tank.
- Fill with water up to 4.0L. If the water is filled up above the mark, it can spill out when the door opens and closes.
- Push the cap until you hear a click.

Getting water from the dispenser

Place a glass underneath the water outlet and push it gently against the water dispenser lever with your glass. Blue light will turn on when you push the lever.



- Make sure the glass is in line with the dispenser to prevent the water from splashing out.
- Water dispenser may not be available depending on the model.



When the water dispenser is not in use, the following is recommended

Fix the water supply device tightly into the fixing hole.
The door will not be closed automatically when the water supply device is pulled out for a long time because of cold leaking.

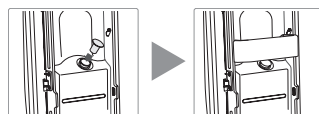

CLEANING THE REFRIGERATOR

Caring for your Samsung Refrigerator prolongs the life of your appliance and helps keep it odor and germ free.

Cleaning the Interior

Clean the inside walls and accessories with a mild detergent and then wipe dry with a soft cloth. You can remove the drawers and shelves for a more thorough cleaning. Just make sure to dry drawers and shelves before putting them back into place.

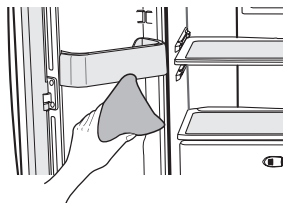

Cleaning the Exterior

Wipe the display panel with damp, clean, soft cloth. Do not spray water directly on the surface of the Refrigerator. The doors, handles and cabinet surfaces should be cleaned with a mild detergent and then wiped dry with a soft cloth. To keep your appliance looking its best, the exterior should be polished once or twice a year.

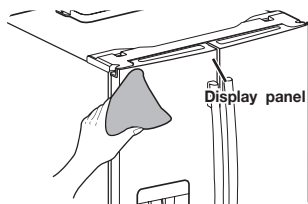

Do not use Benzene, Thinner, car detergent, or Clorox for cleaning. They may damage the surface of the appliance and may cause fire.



Cleaning the Rubber door seals

If the rubber door seals are dirty, the doors may not close properly, and the Refrigerator will not operate efficiently. Keep the door seals free of grit or grime by cleaning the doors with a mild detergent and damp cloth. Wipe dry with a clean, soft cloth.

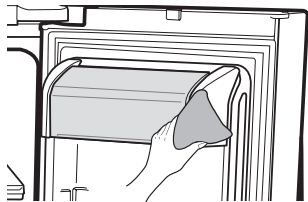

Cleaning behind the Refrigerator

To keep cords and exposed parts free of dust and dirt accumulation, vacuum behind the appliance once or twice a year.



Do not remove the back cover. Doing so may cause an electric shock.

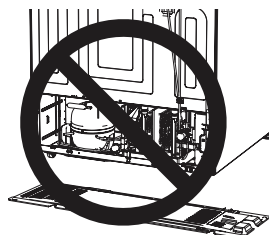

operating your samsung refrigerator

REPLACING THE INTERIOR LIGHT



For LED lamp, please contact service engineer to replace it.

troubleshooting

PROBLEM	SOLUTION
<p>The Refrigerator does not work at all or it does not chill sufficiently.</p>	<ul style="list-style-type: none"> • Check that the power plug is properly connected. • Is the temperature control on the display panel set to the correct temperature? Try setting it to a lower temperature. • Is the refrigerator in direct sunlight or located near a heat source? • Is the back of the refrigerator so close to the wall that air cannot keep circulating? (Refer to page 10 for the best location.)
<p>The food in the Refrigerator is frozen.</p>	<ul style="list-style-type: none"> • Is the temperature control on the display set to the correct temperature? Try setting it to a warmer temperature. • Is the temperature in the room too low? • Did you store the food too close to the air vent at the back of the refrigerator? Move the food away from the air vent.
<p>You hear unusual noise or sounds.</p>	<ul style="list-style-type: none"> • Check that the refrigerator is level and stable. • Is the back of the refrigerator too close to the wall and therefore keeping air from circulating? • Was anything dropped behind or under the refrigerator? • A “ticking” sound is heard from inside the refrigerator. It is normal and occurs because various accessories are contracting or expanding according to the temperature of the refrigerator interior. • When the automatic ice maker is on, ice is made in the ice container. After the ice is made, the container inverts and the ice falls into the storage compartment and water flows through the water valve. These operations cause noise at regular intervals, but that noise is normal.
<p>The front corners and horizontal hinged section of the appliance are hot and condensation is occurring.</p>	<ul style="list-style-type: none"> • Some heat is normal as anti-condensators are installed in the horizontal hinged section of the refrigerator to prevent condensation. • Is the refrigerator door ajar? Condensation can occur when you leave the door open for a long time.
<p>Ice Maker is not producing ice.</p>	<ul style="list-style-type: none"> • Did you wait for 12 hours after installation of the water supply line before making ice? • Is the water line connected and the shut-off valve opened? • Did you manually stop the ice making function? • Is the freezer temperature too warm? Try setting the freezer temperature lower.
<p>You hear water bubbling in the Refrigerator.</p>	<ul style="list-style-type: none"> • This is normal. The bubbling comes from the refrigerator coolant liquid circulating through the refrigerator.
<p>There is a bad smell in the Refrigerator.</p>	<ul style="list-style-type: none"> • Check for spoiled food. • Foods with strong odors (for example, fish) should be tightly covered. • Clean out your freezer periodically and throw away any spoiled or suspicious food.
<p>Frost forms on the walls of the Freezer.</p>	<ul style="list-style-type: none"> • Is the air vent blocked? Remove any obstructions so air can circulate freely. • Allow sufficient space between the foods stored for efficient air circulation. • Is the freezer drawer closed properly?



CAUTION

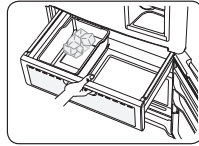
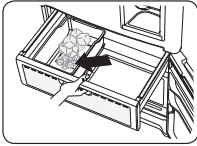

Clean the ice box if there are some small pieces of ice on the bottom.

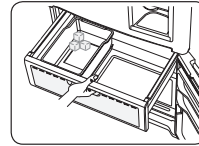
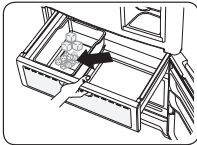

Throw away the coherent ice if the ice maker is not used for long time.

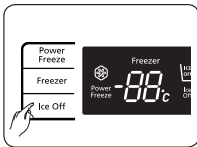

Set "Ice Off" for saving energy if the ice maker will not be used for long time.

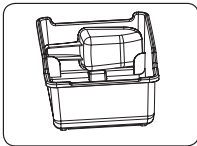

If you want to buy and use a tool of shoveling ice, put it into special place of ice box or take it out.

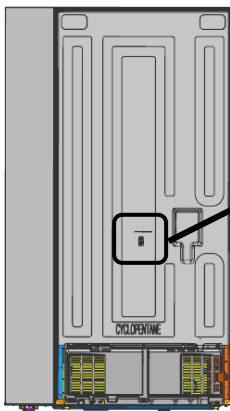

Caution: Please clamp the power cord into the hook to prevent the power cord from being worn or damaged when the refrigerator isn't working or being moved.

memo

memo

Ambient Room Temperature Limits

This fridge/freezer is designed to operate in ambient temperatures specified by its temperature class marked on the rating plate.

Class	Symbol	Ambient Temperature range(°C)
Extended Temperate	SN	+10 to +32
Temperate	N	+16 to +32
Subtropical	ST	+16 to +38
Tropical	T	+16 to +43

NOTE: Internal temperatures may be affected by such factors as the location of the fridge/freezer, ambient temperature and the frequency with which you open the door. Adjust the temperature as required to compensate for these factors.

English



Correct Disposal of This Product (Waste Electrical & Electronic Equipment)

(Applicable in countries with separate collection systems)

This marking on the product, accessories or literature indicates that the product and its electronic accessories (e.g. charger, headset, USB cable) should not be disposed of with other household waste at the end of their working life. To prevent possible harm to the environment or human health from uncontrolled waste disposal, please separate these items from other types of waste and recycle them responsibly to promote the sustainable reuse of material resources.

Household users should contact either the retailer where they purchased this product, or their local government office, for details of where and how they can take these items for environmentally safe recycling.

Business users should contact their supplier and check the terms and conditions of the purchase contract. This product and its electronic accessories should not be mixed with other commercial wastes for disposal.

Contact SAMSUNG WORLD WIDE

If you have any questions or comments relating to Samsung products, please contact the SAMSUNG customer care center.

COUNTRY	CALL	Web site
AUSTRALIA	1300 362 603	www.samsung.com/au/support
COLOMBIA	Bogotá en el 600 12 72 Sin costo en todo el país 01 8000 112 112 Y desde tu celular #726	www.samsung.com/co/support
EIRE	0818 717100	www.samsung.com/ie/support
HONG KONG	3698 4698	www.samsung.com/hk/support (Chinese) www.samsung.com/hk_en/support (English)
INDIA	1800 3000 8282 - Toll Free 1800 266 8282 - Toll Free 1800110011 (Toll Free) 30308282	www.samsung.com/in/support
BANGLADESH	0961-2300300 0800-0300300 (Toll free)	www.samsung.com/support
MALAYSIA	1800-88-9999 603-77137477 (Overseas contact)	www.samsung.com/my/support
NEW ZEALAND	0800 726 786	www.samsung.com/nz/support
PANAMA	800-0101	www.samsung.com/latin/support (Spanish) www.samsung.com/latin_en/support (English)
PHILIPPINES	1-800-10-726-7864 [PLDT Toll Free] 1-800-8-726-7864 [Globe Landline and Mobile] 02- 422-2111 [Standard Landline]	www.samsung.com/ph/support
SINGAPORE	1800-SAMSUNG(726-7864)	www.samsung.com/sg/support
SOUTH AFRICA	0860 SAMSUNG (726 7864)	www.samsung.com/support
UK	0330 SAMSUNG (7267864)	www.samsung.com/uk/support
VIETNAM	1800 588 889	www.samsung.com/vn/support