



# CONTENTS

1. SAFETY INFORMATION.....	2
2. CONDITIONS OF USE.....	5
3. SAFETY INSTRUCTIONS.....	5
4. PRODUCT DESCRIPTION.....	7
5. CONTROL PANEL.....	7
6. PROGRAMME TABLE.....	8
7. OPTIONS.....	9
8. SETTINGS.....	11
9. BEFORE FIRST USE.....	11
10. DAILY USE.....	11
11. HINTS AND TIPS.....	12
12. CARE AND CLEANING.....	13
13. TROUBLESHOOTING.....	16
14. TECHNICAL DATA.....	17
15. WARRANTY .....	17

## WE'RE THINKING OF YOU

Thank you for purchasing an Electrolux appliance. You've chosen a product that brings with it decades of professional experience and innovation. Ingenious and stylish, it has been designed with you in mind. So whenever you use it, you can be safe in the knowledge that you'll get great results every time.

Welcome to Electrolux.

**Visit our website for:**



Get usage advice, brochures, trouble shooter, service information:  
[www.electrolux.com/webselfservice](http://www.electrolux.com/webselfservice)



Register your product for better service:  
[www.registerelectrolux.com](http://www.registerelectrolux.com)

## CUSTOMER CARE AND SERVICE

Always use original spare parts.

When contacting our Authorised Service Centre, ensure that you have the following data available: Model, PNC, Serial Number.

The information can be found on the rating plate.

 Warning / Caution-Safety information

 General information and tips

 Environmental information

Subject to change without notice.

### 1. SAFETY INFORMATION

Before the installation and use of the appliance, carefully read the supplied instructions. The manufacturer is not

responsible if an incorrect installation and use causes injuries and damages. Always keep the instructions with the appliance for future reference.



- Read the supplied instructions.



- Warning; Risk of fire / Flammable materials

## 1.1 Children and vulnerable people safety



**WARNING!**

Risk of suffocation, injury or permanent disability.

- This appliance can be used by children aged from 8 years and above and persons with reduced physical, sensory or mental capabilities or lack of experience and knowledge if they have been given supervision or instruction concerning the use of the appliance in a safe way and understand the hazards involved.
- Do not let children play with the appliance.
- Children aged 3 years and under must be kept away from this appliance when it is in operation at all times.
- Keep all packaging away from children and dispose of it appropriately.
- Keep detergents away from children.
- Keep children and pets away from the appliance door when it is open.
- If the appliance has a child safety device, this should be activated.
- Children shall not carry out cleaning and user maintenance of the appliance without supervision.

## 1.2 General Safety

- Do not change the specification of this appliance.
- If the tumble dryer is put on top of a washing machine, use the stacking kit. The stacking kit, available from your authorized vendor, can be used only with the appliance specified in the instructions, supplied with

the accessory. Read it carefully before installation (Refer to the Installation leaflet).

- The appliance can be installed as freestanding or below the kitchen counter with correct space (Refer to the Installation leaflet).
- Do not install the appliance behind a lockable door, a sliding door or a door with a hinge on the opposite side, that would prevent the appliance door from being fully opened.
- The ventilation opening in the base (if applicable) must not be covered by a carpet, mat, or any floor covering.
- **WARNING:** The appliance must not be supplied through an external switching device, such as timer, or connected to a circuit that is regularly switched on and off by a utility.
- Connect the mains plug to the mains socket only at the end of the installation process. Make sure that the mains plug is accessible after installation.
- Ensure good air ventilation in the located room to avoid the backflow of unwanted gases into the room from appliances burning gas or other fuels, including open fires.
- Exhaust air must not be discharged into a flue which is used for exhausting fumes from any appliances burning gas or other fuels.
- If the mains power supply cable is damaged, it must be replaced by the manufacturer, its Authorised Service Centre or similarly qualified persons to avoid an electrical hazard.
- Do not exceed the maximum load of 7 kg (refer to the "Programme chart" chapter).
- Do not use the appliance if items have been soiled with industrial chemicals.
- Wipe away lint or packaging debris that has accumulated around the appliance.
- Do not run the appliance without a filter. Clean the lint filter before or after each use.

- Do not dry unwashed items in the tumble dryer.
- Items that have been soiled with substances such as cooking oil, acetone, alcohol, petrol, kerosene, spot removers, turpentine, waxes and wax removers should be washed in hot water with an extra amount of detergent before being dried in the tumble dryer.
- Items such as foam rubber (latex foam), shower caps, waterproof textiles, rubber backed articles and clothes or pillows fitted with foam rubber pads should not be dried in the tumble dryer.
- Fabric softeners, or similar products, should only be used as specified by the product manufacturer's instructions.
- Remove all objects from items that could be a source of fire ignition such as lighters or matches.
- Never stop a tumble dryer before the end of the drying cycle unless all items are quickly removed and spread out so that the heat is dissipated.
- The final part of a tumble dryer cycle occurs without heat (cool down cycle) to ensure that the items are left at a temperature that ensures that the items will not be damaged.
- Before any maintenance operation, deactivate the appliance and disconnect the mains plug from the socket.

## 2. CONDITIONS OF USE

This appliance is intended to be used in household and similar applications such as:

- Farm houses

- By clients in serviced apartments, holiday apartments and other residential type environments.

## 3. SAFETY INSTRUCTIONS

### 3.1 Installation

- Remove all the packaging.
- Do not install or use a damaged appliance.
- Follow the installation instruction supplied with the appliance.
- Always take care when moving the appliance as it is heavy. Always use safety gloves and enclosed footwear.
- Do not install or use the appliance where the temperature can be less than 5°C or higher than 35°C.

- The floor area where the appliance is to be installed must be flat, stable, heat resistant and clean.
- Make sure that there is air circulation between the appliance and the floor.
- Always keep the appliance vertical when being moved.
- The rear surface of the appliance must be put against the wall.
- When the appliance is in its permanent position, check that it is fully level with the aid of a spirit level. If it is not, adjust the feet accordingly.

### 3.2 Electrical connection



#### **WARNING!**

Risk of fire and electrical shock.

- The appliance must be earthed.
- Make sure that the electrical information on the rating plate agrees with the power supply. If not, contact an electrician.
- Always use a correctly installed shockproof socket.
- Do not use multi-plug adapters and extension cables.
- Do not pull the mains cable to disconnect the appliance. Always pull the mains plug.
- Do not touch the mains cable or the mains plug with wet hands.
- This appliance complies with the E.E.C. Directives.

### 3.3 Use



#### **WARNING!**

Risk of injury, electrical shock, fire, burns or damage to the appliance.

- Do not dry the damaged items which contain padding or fillings.
- Only dry fabrics which are applicable to dry in the tumble dryer. Follow the instructions on the fabric label.
- If you have washed your laundry with a stain remover start an extra rinse cycle before you start the dryer.
- Do not drink or prepare food with the condensed water/distilled water. It can

cause health problems to people and pets.

- Do not sit or stand on the open door.
- Do not dry dripping wet clothes in the tumble dryer.
- Oil-affected items can ignite spontaneously, especially when exposed to heat sources such as in a tumble dryer. The items become warm, causing an oxidation reaction in the oil. Oxidation creates heat. If the heat cannot escape, the items can become hot enough to catch fire. Piling, stacking or storing oil-affected items can prevent heat from escaping and create a fire hazard.
- If it is unavoidable that fabrics that contain vegetable or cooking oil or have been contaminated by hair care products be placed in a tumble dryer they should first be washed in hot water with extra detergent -this will reduce, but not eliminate, the hazard.

### 3.4 Care and cleaning



#### **WARNING!**

Risk of injury or damage to the appliance.

- Do not use water spray and steam to clean the appliance.
- Clean the appliance with a moist soft cloth. Only use neutral detergents. Do not use any abrasive products, abrasive cleaning pads, solvents or metal objects.

### 3.5 Compressor



#### **WARNING!**

Risk of damage to the appliance.

- The compressor and its system in the tumble dryer is filled with the special agent which is free from fluoro-chloro-hydrocarbons. This system must stay tight. The damage of the system can cause a leakage.

### 3.6 Disposal



#### **WARNING!**

Risk of injury or suffocation.

- Disconnect the appliance from the mains electrical and water supplies.
- Cut off the mains electrical cable close to the appliance and dispose of it.
- Remove the door catch to prevent children or pets from becoming trapped in the drum.
- Dispose of the appliance in accordance with local requirements for the disposal of Waste Electrical and Electronic Equipment (WEEE).

## 4. PRODUCT DESCRIPTION

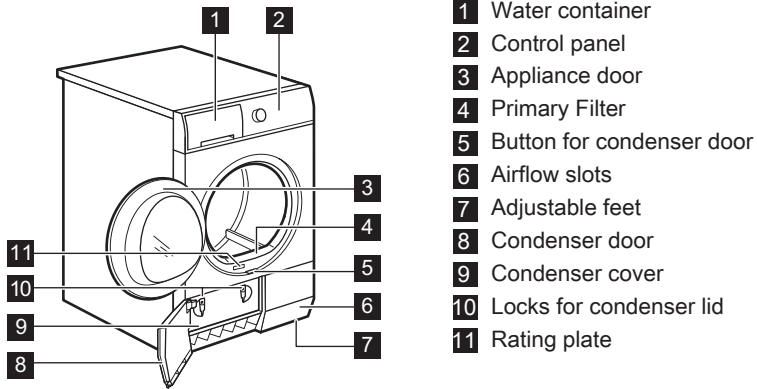



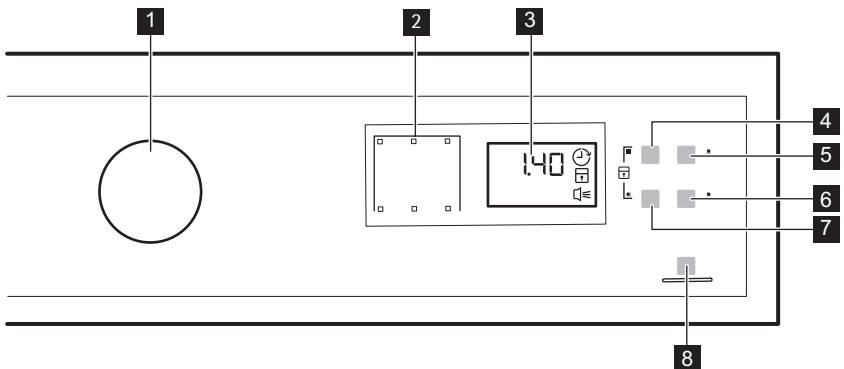

- 1** Water container
- 2** Control panel
- 3** Appliance door
- 4** Primary Filter
- 5** Button for condenser door
- 6** Airflow slots
- 7** Adjustable feet
- 8** Condenser door
- 9** Condenser cover
- 10** Locks for condenser lid
- 11** Rating plate

**i** For ease of loading laundry or ease of installation the door is reversible. (see separate leaflet).

## 5. CONTROL PANEL











- 1** Programme knob and **⓪** OFF switch
- 2** Indicators
- 3** Display
- 4**
- 5**
- 6**
- 7**
- 8**











- 4  Time touchpad
- 5  Delay touchpad
- 6  Buzzer touchpad
- 7  Delicate touchpad
- 8  Start/Pause touchpad

 Touch the touchpads with your finger in the area with the symbol or name of the option. Do not wear gloves when you operate with the control panel. Make sure that the control panel is always clean and dry.





















## 5.1 Indicators

Indicators	Description
	Drying phase
	Cooling phase
	Crease guard phase
	Condenser
	Water container
	Filter
	Delay start
	Child lock
	Acoustic signals
2.00	Programme duration
10' - 2.00	Time Drying duration
30' - 20 h	Delay start duration

## 6. PROGRAMME TABLE

Programmes	Type of load	Load (max.) <sup>1)</sup> / Fabric mark
 Cotton		
 Extra Dry	Drying level: extra dry.	7kg/  
 Strong Dry	Drying level: strong dry.	7kg/  
 Cupboard Dry <sup>2)</sup>	Drying level: cupboard dry.	7kg/  



Programmes	Type of load	Load (max.) <sup>1)</sup> / Fabric mark
 Iron Dry <sup>2)</sup>	Drying level: suitable for ironing.	7kg/ 
 <b>Synthetic</b>		
 Extra Dry	Drying level: extra dry.	3kg/ 
 Cupboard Dry <sup>2)</sup>	Drying level: cupboard dry.	3kg/ 
 Iron Dry	Drying level: suitable for ironing.	3kg/ 
 Mixed	Cotton and synthetic fabrics. Low temperature programme. Delicate programme with warm air.	2kg/ 
 Time Drying	With this program you can use the Time option and set the programme duration.	7kg/ 
 Refresh	Refreshing a textiles that were in storage.	1kg
 Wool Refresh	Refreshing a wool fabrics. Wool items become soft and cosy. Remove the items immediately after the programme end.	1kg
 Delicates	Delicate fabrics.	2kg/ 
 Sports	Sportswear, thin and light fabrics, micro-fiber, polyester.	2kg/ 
 Easy Iron	Easy care fabrics for which a minimum of ironing is necessary. The drying results can be different from one type of fabric to another. Shake the items before putting them in the appliance. When the programme has ended, immediately remove the items and put them on a hanger.	1kg (or 5 shirts)/ 

1) The maximum weight refers to dry items.

2) **For test institutes only:** Standard programs for tests are specified in the EN 61121 document.

## 7. OPTIONS

### 7.1 Time

This option is applicable only to the Time Drying programme. You can set the programme duration, from a minimum of 10 minutes to a maximum of 2 hours. The setting of the duration is related to the quantity of laundry in the appliance.



We recommend that you set a short duration for small quantities of laundry or for only one item.

## 7.2 Delicate

With this option you can set a delicate drying programme that has a low temperature. Use this option with a fabrics that have the symbol  on the fabric label (e.g. acrylic, viscose).

- cycle end
- start and end of crease guard phase
- cycle interruption



















The buzzer function is by default always on. You can use this function to activate or deactivate the sound.

## 7.3 Buzzer

you can hear the buzzer at the:

-  You can activate the Buzzer option with all programmes.

## 7.4 Options table

Programmes <sup>1)</sup>			
 Cotton			
 Extra Dry		■	■
 Strong Dry		■	■
 Cupboard Dry		■	■
 Iron Dry		■	■
 Synthetic			
 Extra Dry		■	■
 Cupboard Dry		■	■
 Iron Dry		■	■
 Mixed			■
 Time Drying	■	■	■
 Refresh			■
 Wool Refresh		■	■
 Delicates		■	■
 Sports		■	■
 Easy Iron		■	■

<sup>1)</sup> Together with the program you can set 1 or more options. To activate or deactivate them, press the related touchpad.

## 8. SETTINGS

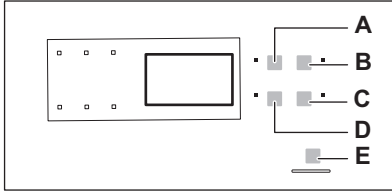

- A. Time touchpad
- B. Delay touchpad
- C. Buzzer touchpad
- D. Delicate touchpad
- E. Start/Pause touchpad

### 8.1 Child lock function

This option prevents children to play with the appliance while a programme operates. The programme knob and the touchpads are locked.

Only OFF switch is unlocked.

Activating the child lock option:

1. Use the programme knob to set any programme.
2. Wait approximately 8 seconds.
3. Press and hold touchpads (A) and (D) at the same time. The child lock indicator comes on.

The child lock indicator comes on.



It is possible to deactivate the child lock option while a programme operates. Press and hold the same touchpads until the child lock indicator goes off.

### 8.2 Adjustment of the remaining laundry moisture degree

To change the default degree of the remaining moisture of the laundry:

1. Use the programme knob to set any programme.
2. Wait approximately 8 seconds.
3. Press and hold buttons (A) and (B) at the same time.

One of the these indicators comes on:

- the maximum dry laundry
  - the more dry laundry
  - the standard dry laundry
4. Press the button (E) again and again until the indicator of the correct level comes on.
  5. To confirm the adjustment, press and hold buttons (A) and (B) at the same time for approximately 2 seconds.

## 9. BEFORE FIRST USE

Before you use the appliance for the first time:

- Clean the tumble dryer drum with a moist cloth.

- Start a short programme (e.g. 30 minutes) with moist laundry.

## 10. DAILY USE

### 10.1 Start a programme without delay start

1. Prepare the laundry and load the appliance.



#### CAUTION!

Make sure that when you close the door, the laundry does not catch between the appliance door and the rubber seal.

2. Set the correct programme and options for the type of load.

The display shows the programme duration.

 The drying time you see is related to the load of 5 kg for cotton and jeans programmes. For the other programmes the drying time is related to the recommended loads. The drying time of the cotton and jeans programmes with the load more than 5 kg is longer.

3. Press the Start/Pause touchpad. The programme starts.

## 10.2 Starting the programme with delay start

1. Set the correct programme and options for the type of load.
2. Press the delay start button again and again until the display shows the delay time you want to set.

 You can delay the start of a programme from a minimum of 30 minutes to a maximum of 20 hours.

3. Press the Start/Pause touchpad. The display shows the countdown of the delay start.



When the countdown is completed, the programme starts.

## 10.3 Change a programme

1. Turn the Programme knob to  OFF
2. Set the programme.

## 10.4 At the end of the programme

When the programme is completed:



- An intermittent acoustic signal operates.
- The indicator  flashes.
- The indicator  flashes.
- The Start/Pause indicator is on.

The appliance continues to operate with the crease guard phase for approximately other 30 minutes.

The crease guard phase prevents creases from your laundry.

You can remove the laundry before the crease guard phase is completed. We recommend, for better results, that you remove the laundry when the phase is almost completed.

When the crease guard phase is completed:

- The indicator  is on but does not flash.
- The indicator  is on but does not flash.
- Start/Pause indicator goes off.

1. Turn the Programme knob to  OFF
2. Open the appliance door.
3. Remove the laundry.
4. Close the appliance door.

 Always clean the filter and empty the water container when a programme is completed.

## 10.5 Stand-by function

To decrease the energy consumption, this function automatically deactivates the appliance:





- After 5 minutes if you do not start the programme.
- After 5 minutes from the end of the programme.

# 11. HINTS AND TIPS

## 11.1 Preparing the laundry

- Close the zippers.
- Close the fasteners of duvet covers.
- Do not dry ties or ribbons loose (e.g. apron ribbons). Tie them before you start a programme.
- Remove all items from pockets.

- If an item has an internal layer made of cotton, turn it inside out. Make sure that the cotton layer is always facing outward.
- We recommend that you set a correct programme suitable for the type of fabrics that are in the appliance.
- Do not put dark colours together with light colours.
- Use a suitable programme for cotton, jersey and knitwear to prevent shrinkage.
- Make sure that the load do not exceeds the maximum load stated in programs chapter or shown on the display.
- Only dry laundry that is suitable for tumble drying. Refer to the fabric label on the items.
- Do not dry large and small items together. Small items can be trapped inside the large items and remain wet.

Fabric label	Description
	Laundry is suitable for tumble drying.
	Laundry is suitable for tumble drying at higher temperatures.
	Laundry is suitable for tumble drying at low temperatures only.
	Laundry is not suitable for tumble drying.

## 12. CARE AND CLEANING

### 12.1 Cleaning the filter

1.

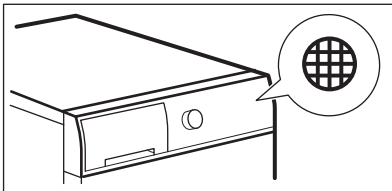

2.

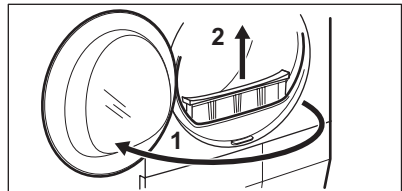

3.

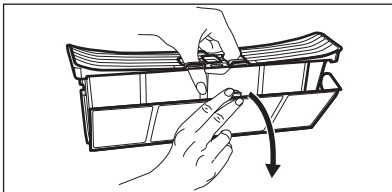

4.



5.1)

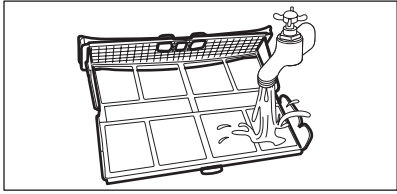

1) if necessary, clean the filter with hot water.

6.

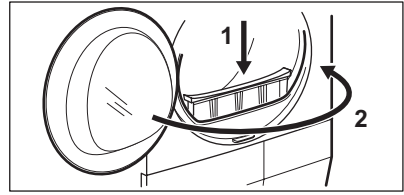

## 12.2 Emptying the water container

1.

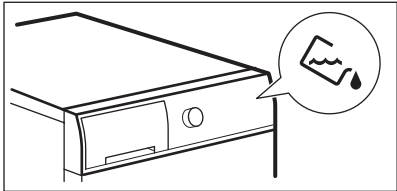

2.

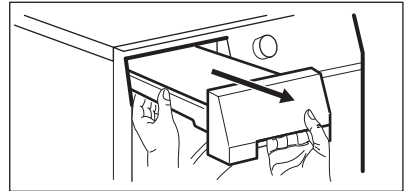

3.

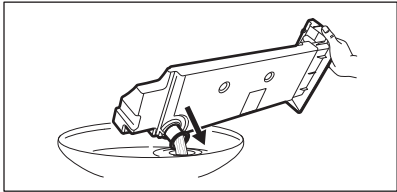

4.

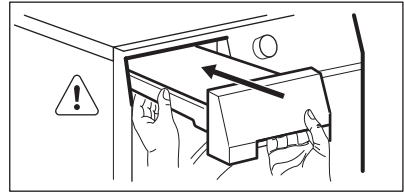

You can use the water from the water container as an alternative to distilled water (e.g. for steam ironing). Before you use the water, remove dirt residues with a filter.

## 12.3 Cleaning the condenser

1.

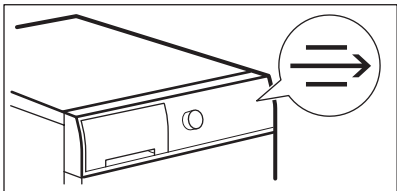

2.

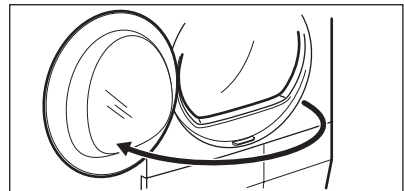

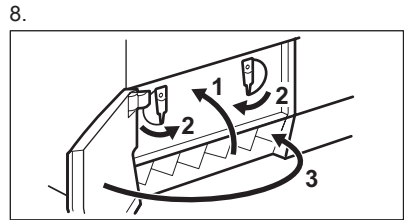
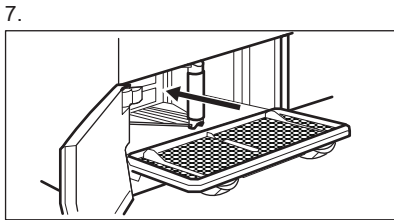
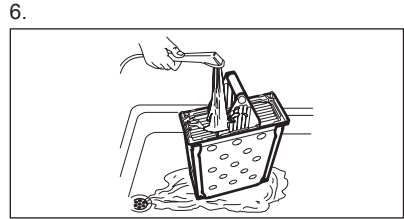
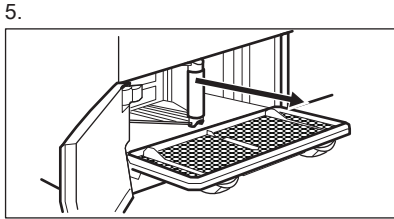
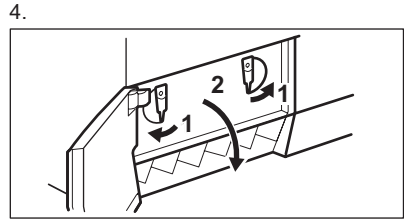
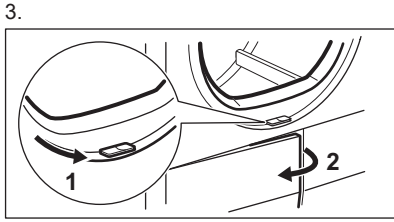

## 12.4 Cleaning the drum

**WARNING!**  
 Disconnect the appliance before you clean it.

Use a standard neutral soap detergent to clean the inner surface of the drum and drum lifters. Dry the cleaned surfaces with a soft cloth.

**CAUTION!**  
 Do not use abrasive materials or steel wool to clean the drum.

Use a moist cloth to clean. Dry the cleaned surfaces with a soft cloth.

**CAUTION!**  
 Do not use furniture cleaning agents or cleaning agents which can cause corrosion to clean the appliance.

## 12.5 Cleaning the control panel and housing

Use a standard neutral soap detergent to clean the control panel and housing.

## 12.6 Cleaning the airflow slots

Use a vacuum cleaner to remove fluff from the airflow slots.

## 13. TROUBLESHOOTING

Problem	Possible solution
You cannot activate the appliance.	Make sure that the mains plug is connected to the mains socket.
	Check fuse in fuse box (domestic installation).
The programme does not start.	Press Start/Pause.
	Make sure that the appliance door is closed.
The appliance door does not close.	Make sure that the installation of the filter is correct.
	Make sure that the laundry does not catch between the appliance door and the rubber seal.
The appliance stops during operation.	Make sure that the water container is empty. Press Start/Pause to start the programme again.
The cycle time is too long or unsatisfactory drying result. <sup>1)</sup>	Make sure that the weight of the laundry is applicable to the duration of the programme.
	Make sure that the filter is clean.
	The laundry is too wet. Spin the laundry in the washing machine again.
	Ensure that the room temperature is higher than +5°C and lower than +35°C. Optimal room temperature is 19°C to 24°C.
	Set the Time Drying or the Extra Dry programme. <sup>2)</sup>
The display shows <b>Err</b> .	If you want to set a new programme, deactivate and activate the appliance.
	Make sure that the options are applicable to the programme.
The display shows (e.g. <b>E51</b> ).	Deactivate and activate the appliance. Start a new programme. If the problem occurs again, contact the Service.

<sup>1)</sup> After maximum 5 hours, the programme ends automatically.

<sup>2)</sup> It can happen that some area remains humid when drying big items (e.g. bed sheets).

### If the drying results are not satisfactory

- The set programme was incorrect.

- The filter is clogged.
- The condenser is clogged.



- There was too much laundry in the appliance.
- The drum is dirty.
- Incorrect setting of the conductivity sensor ( See chapter "*Settings - Adjustment of the remaining laundry moisture degree*" for better setting).
- The airflow slots are clogged.
- Room temperature is too low or too high ( optimal room temperature 19°C to 24°C )

## 14. TECHNICAL DATA

Height x Width x Depth	850 x 600 x 540 mm (maximal 570 mm)
Max. depth with the appliance door open	1030 mm
Max. width with the appliance door open	950 mm
Adjustable height	850 mm (+ 15 mm - feet regulation)
Drum volume	104 l
Maximum load volume	7 kg
Voltage	230-240 V
Frequency	50 Hz
Necessary fuse	10 A
Total power	2250 W
Left—on mode power absorption	0,41 W
Off mode power absorption	0,41 W
Type of use	Household
Permitted ambient temperature	+ 5°C to + 35°C
Level of protection against ingress of solid particles and moisture ensured by the protective cover, except where the low voltage equipment has no protection against moisture	<b>IPX4</b>

## 15. WARRANTY

FOR SALES IN AUSTRALIA AND NEW ZEALAND

APPLIANCE: ELECTROLUX DRYER

**This document sets out the terms and conditions of the product warranties for Electrolux Appliances. It is an important document. Please keep it with your proof of purchase documents in a safe place for future reference should you require service for your Appliance.**

- In this warranty:
  - 'acceptable quality' as referred to in clause 10 of this warranty has the same meaning referred to in the ACL;
  - 'ACL' means Schedule 2 to the Competition and Consumer Act 2010;
  - 'Appliance' means any Electrolux product purchased by you and accompanied by this document;

- d) 'ASC' means Electrolux authorised service centres;
  - e) 'Electrolux' means Electrolux Home Products Pty Ltd of 163 O'Riordan Street, Mascot NSW 2020, ABN 51 004 762 341 in respect of Appliances purchased in Australia and Electrolux (NZ) Limited (collectively 'Electrolux') of 3-5 Niall Burgess Road, Mount Wellington, in respect of Appliances purchased in New Zealand;
  - f) 'major failure' as referred to in clause 10 of this warranty has the same meaning referred to in the ACL and includes a situation when an Appliance cannot be repaired or it is uneconomic for Electrolux, at its discretion, to repair an Appliance during the Warranty Period;
  - g) 'Warranty Period' means the Appliance is warranted against manufacturing defects in Australia for 24 months and in New Zealand for 24 months, following the date of original purchase of the Appliance;
  - h) 'you' means the purchaser of the Appliance not having purchased the Appliance for re-sale, and 'your' has a corresponding meaning.
2. This warranty only applies to Appliances purchased and used in Australia or New Zealand and used in normal domestic applications and is in addition to (and does not exclude, restrict, or modify in any way) any non-excludable statutory warranties in Australia or New Zealand.
  3. During the Warranty Period Electrolux or its ASC will, at no extra charge if your Appliance is readily accessible for service, without special equipment and subject to these terms and conditions, repair or replace any parts which it considers to be defective. Electrolux or its ASC may use remanufactured parts to repair your Appliance. You agree that any replaced Appliances or parts become the property of Electrolux.

This warranty does not apply to light globes, batteries, filters or similar perishable parts.

4. Parts and Appliances not supplied by Electrolux are not covered by this warranty.
5. To the extent permitted by law, you will bear the cost of transportation, travel and delivery of the Appliance to and from Electrolux or its ASC. If you reside outside of the service area, you will bear the cost of:
  - a) travel of an authorised representative;
  - b) transportation and delivery of the Appliance to and from Electrolux or its ASC,

In all instances, unless the Appliance is transported by Electrolux or an Electrolux authorised representative, the Appliance is transported at the owner's cost and risk while in transit to and from Electrolux or its ASC.

6. Proof of purchase is required before you can make a claim under this warranty.
7. You may not make a claim under this warranty unless the defect claimed is due to faulty or defective parts or workmanship. Electrolux is not liable in the following situations (which are not exhaustive):
  - a) the Appliance is damaged by:
    - accident
    - misuse or abuse, including failure to properly maintain or service
    - normal wear and tear
    - power surges, electrical storm damage or incorrect power supply
    - incomplete or improper installation
    - incorrect, improper or inappropriate operation
    - insect or vermin infestation
    - failure to comply with any additional instructions supplied with the Appliance;
  - b) the Appliance is modified without authority from Electrolux in writing;

- c) the Appliance's serial number or warranty seal has been removed or defaced;
- d) the Appliance was serviced or repaired by anyone other than Electrolux, an authorised repairer or ASC.
8. This warranty, the contract to which it relates and the relationship between you and Electrolux are governed by the law applicable where the Appliance was purchased. Where the Appliance was purchased in New Zealand for commercial purposes the Consumer Guarantee Act does not apply.
9. To the extent permitted by law and subject to your non excludable statutory rights and warranties, Electrolux excludes all warranties and liabilities (other than as contained in this document) including liability for any loss or damage whether direct or indirect arising from your purchase, use or non use of the Appliance.
10. For Appliances and services provided by Electrolux in Australia, the Appliances come with a guarantee by Electrolux that cannot be excluded under the ACL. You are entitled to a replacement or refund for a major failure and for compensation for any other reasonably foreseeable loss or damage. You are also entitled to have the Appliance repaired or replaced if the Appliance fails to be of acceptable quality and the failure does not amount to a major failure. The benefits to you given by this warranty are in addition to your other rights and remedies under a law in relation to the Appliances or services to which the warranty relates.
11. At all times during the Warranty Period, Electrolux shall, at its discretion, determine whether repair, replacement or refund will apply if an Appliance has a valid warranty claim applicable to it.
12. For Appliances and services provided by Electrolux in New Zealand, the Appliances come with a guarantee by Electrolux pursuant to the provisions of the Consumer Guarantees Act, the Sale of Goods Act and the Fair Trading Act.
13. To enquire about claiming under this warranty, please follow these steps:
- carefully check the operating instructions, user manual and the terms of this warranty;
  - have the model and serial number of the Appliance available;
  - have the proof of purchase (e.g. an invoice) available;
  - telephone the numbers shown below.
14. You accept that if you make a warranty claim, Electrolux and its ASC may exchange information in relation to you to enable Electrolux to meet its obligations under this warranty

### Important Notice

Before calling for service, please ensure that the steps listed in clause 13 above have been followed.

#### FOR SERVICE

or to find the address of your nearest state service centre in Australia

**Please call 13 13 49**

For the cost of a local call (Australia only)

#### SERVICE AUSTRALIA

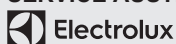

**ELECTROLUX HOME PRODUCTS**

[www.electrolux.com.au](http://www.electrolux.com.au)

#### FOR SPARE PARTS

or to find the address of your nearest state spare parts centre in Australia

**Please call 13 13 50**

For the cost of a local call (Australia only)

**FOR SERVICE**

or to find the address of your nearest authorised service centre in New Zealand

**Free call 0800 10 66 10**

(New Zealand only)

**SERVICE NEW ZEALAND**



**Electrolux**

**ELECTROLUX (NZ) Limited**

[www.electrolux.co.nz](http://www.electrolux.co.nz)

**FOR SPARE PARTS**

or to find the address of your nearest state spare parts centre in New Zealand

**Free call 0800 10 66 20**

(New Zealand only)

## 16. ENVIRONMENTAL CONCERNS

Recycle the materials with the symbol



. Put the packaging in applicable containers to recycle it. Help protect the environment and human health and to recycle waste of electrical and electronic appliances. Do not dispose appliances

marked with the symbol  with the household waste. Return the product to your local recycling facility or contact your municipal office.







