

ASSEMBLY

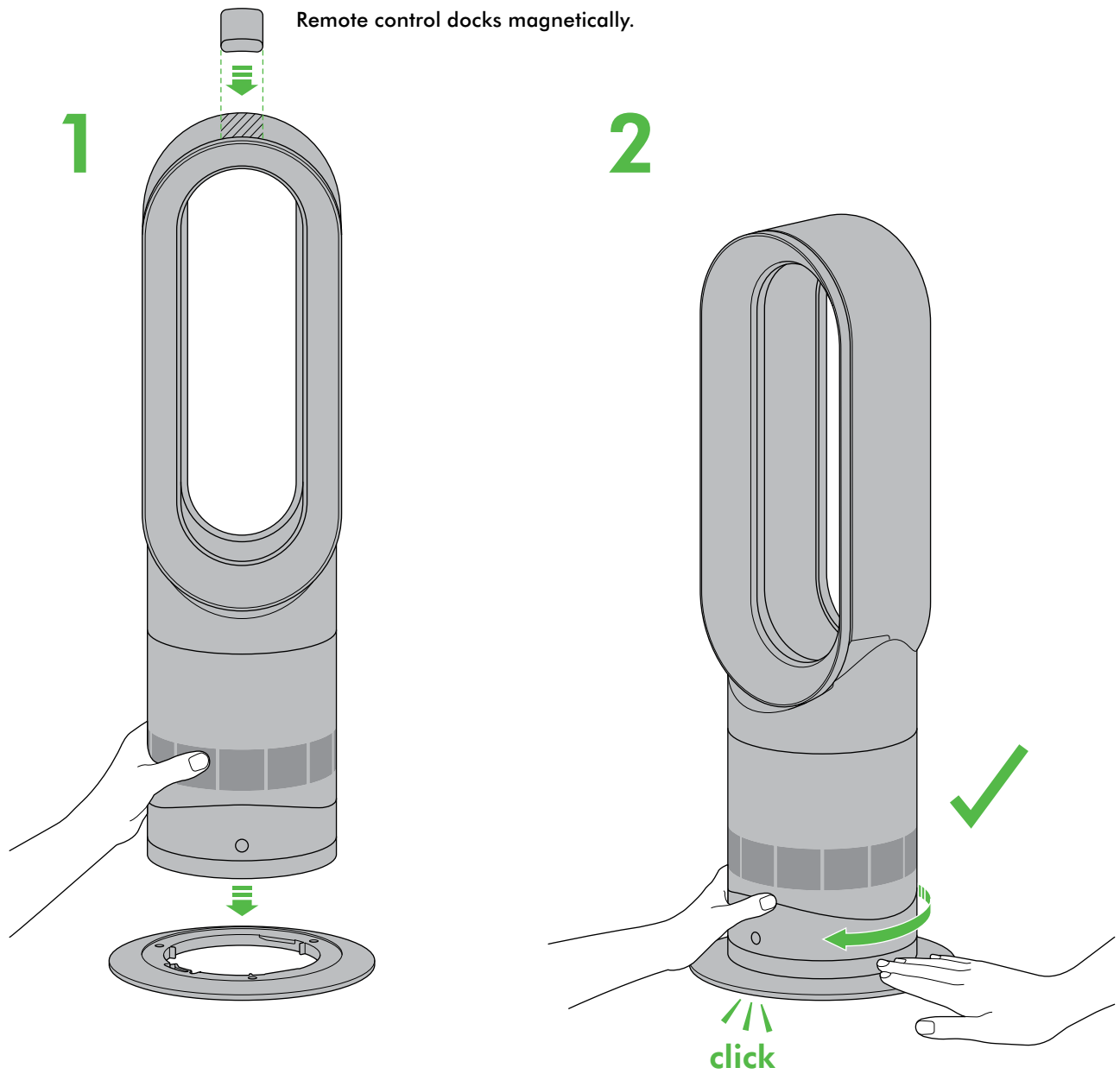

REGISTER
YOUR DYSON 2 YEAR
GUARANTEE TODAY

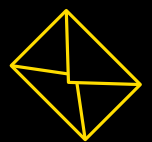

DYSON CUSTOMER CARE

THANK YOU FOR CHOOSING TO BUY A DYSON APPLIANCE

Your Dyson appliance will be covered for parts and labour for 2 years from the date of purchase, as detailed in the terms of the Dyson guarantee in this Dyson Operating Manual.

If you have a query about your Dyson appliance, call the Dyson Customer Care Helpline quoting your serial number and details of where and when you bought the appliance. Alternatively, contact us via the website.

Your serial number can be found on your rating plate which is on the base of the appliance.

Most queries can be solved over the phone by one of our Dyson Customer Care Helpline staff (details below).

Visit our website to register your Dyson full parts and labour guarantee online.

AU: www.dyson.com.au/register

NZ: www.dyson.co.nz/register

Note your serial number for future reference.



This illustration is for example purposes only.

3 EASY WAYS TO REGISTER YOUR DYSON 2 YEAR GUARANTEE

REGISTER ONLINE



Visit our website to register your Dyson full parts and labour guarantee online.

AU: www.dyson.com.au/register

NZ: www.dyson.co.nz/register

REGISTER BY PHONE



Call our dedicated Helpline.

AU 1800 239 766

NZ 0800 397 667

REGISTER BY MAIL

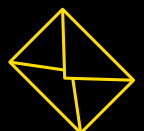

Complete and return the form to Dyson in the envelope supplied.

IMPORTANT SAFETY INSTRUCTIONS

BEFORE USING THIS APPLIANCE READ ALL INSTRUCTIONS AND CAUTIONARY MARKINGS IN THIS MANUAL AND ON THE APPLIANCE

When using an electrical appliance, basic precautions should always be followed, including the following:

WARNING

THE FAN AND THE REMOTE CONTROL BOTH CONTAIN MAGNETS.

1. Pacemakers and defibrillators may be affected by strong magnetic fields. If you or someone in your household has a pacemaker or defibrillator, avoid placing the remote control in a pocket or near to the device.
2. Credit cards and electronic storage media may also be affected by magnets and should be kept away from the remote control and the top of the appliance.

WARNING

These warnings apply to the appliance, and also where applicable, to all tools, accessories, chargers or mains adaptors.

TO REDUCE THE RISK OF FIRE, ELECTRIC SHOCK, OR INJURY:

3. When used in heating mode the appliance is hot when in use and for a short period after use. To avoid burns, do not let bare skin touch hot surfaces. When moving the appliance hold it by the base, not the air loop amplifier.
4. Keep combustible materials, such as furniture, pillows, bedding, papers, clothes and curtains, at least 0.9m (3 feet) from the front of the appliance and keep them away from the sides and rear when the appliance is plugged in.
5. This Dyson appliance is not intended for use by persons (including children) with reduced physical, sensory or mental capabilities, or lack of experience and knowledge, unless they have been given supervision or instruction by a responsible person concerning use of the appliance to ensure that they can use it safely.
6. Use only as described in this Dyson Operating Manual. Do not carry out any maintenance other than that shown in this manual, or advised by the Dyson Customer Care Helpline. Any other use not recommended by the manufacturer may cause fire, electric shock, or injury to persons.
7. The base must be fitted securely before operating. Do not dismantle or use without the base fitted.
8. Do not allow to be used as a toy. Close attention is necessary when used by or near children. Children should be supervised to ensure that they do not play with the appliance or remote control.
9. Suitable for dry locations ONLY. Do not use outdoors or on wet surfaces. Do not use in bathrooms, laundry areas or similar indoor locations. Never locate the appliance where it may fall into a bath or other water container. Do not use or store where it may get wet or in the immediate surroundings of a bath, a shower, or a swimming pool.
10. This appliance has hot parts inside. Do not use it in areas where petrol, paint, or flammable liquids are used or stored or where their vapours are present. Do not use in conjunction with or directly next to an air freshener or similar products.
11. Do not locate directly below a mains electricity supply socket.
12. Always plug directly into a wall socket. Never use with an extension cable as overloading may result in the cable overheating and catching fire.
13. Do not handle any part of the plug or appliance with wet hands.
14. Do not use with a damaged cable or plug. If the supply cable is damaged it must be replaced by Dyson, its service agent or similarly qualified person in order to avoid a hazard.
15. Do not unplug by pulling on the cable. To unplug, grasp the plug, not the cable.
16. Do not stretch the cable or place the cable under strain. Keep cable away from heated surfaces.
17. Do not run cable under carpeting. Do not cover cable with throw rugs, runners or similar coverings. Arrange cable away from traffic area and where it will not be tripped over.
18. To prevent a possible fire, do not use with any opening or exhaust blocked, and keep free of dust, lint, hair, and anything that may reduce airflow. Do not put any object into the inlet grill or the exhaust opening as this may cause an electric shock or fire, or damage the appliance.
19. Do not use on soft surfaces, such as a bed, where openings may become blocked.
20. In order to avoid overheating, do not cover the heater.
21. For the best performance, place on the floor, in the corner of the room, at least 1m from any wall and facing into the centre of the room.
22. Turn off all controls before unplugging.
23. Do not use any cleaning agents or lubricants on this appliance. Unplug before cleaning or carrying out any maintenance.
24. If there is a loose fit between the plug and the socket or the plug becomes very hot, the socket may need to be replaced. Check with a qualified electrician to replace the socket.
25. Choking hazard - This remote control unit contains a small battery. Keep the remote control away from children and do not swallow the battery. If the battery is swallowed seek medical advice at once.
26. If the appliance is not working as it should, has received a sharp blow, has been dropped, damaged, left outdoors, or dropped into water, do not use and contact the Dyson Customer Care Helpline.
27. Contact the Dyson Customer Care Helpline when service or repair is required. Do not disassemble the appliance as incorrect reassembly may result in an electric shock or fire.

IMPORTANT SAFETY FEATURES

For your safety this appliance is fitted with automatic cut-out switches that operate if it tips over or overheats. If the switches operate, unplug the appliance and allow it to cool. Before restarting, check and clear any blockages and ensure the appliance is on a solid level surface.

READ AND SAVE THESE INSTRUCTIONS

THIS DYSON APPLIANCE IS INTENDED FOR HOUSEHOLD USE ONLY

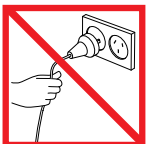

Do not pull on the cable.



In order to avoid overheating and fire hazard, do not cover the appliance.

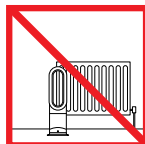

Do not store near heat sources.



Do not carry by the air loop amplifier. The air loop amplifier is not a handle.



Do not use near naked flames.



Each time the heating mode is selected, it conducts a short calibration cycle. Airflow will be automatically controlled during this cycle. Once the calibration cycle is complete, it will revert to the selected airflow speed.

On first use, the appliance will default to a temperature 3°C higher than the detected room temperature. Thereafter, the appliance will remember the last target temperature set.

Select the desired room temperature. Pressing the large red button increases the target temperature by 1°C; the smaller red button decreases it by 1°C. The appliance will not operate in heater mode unless the target temperature is above the room temperature.

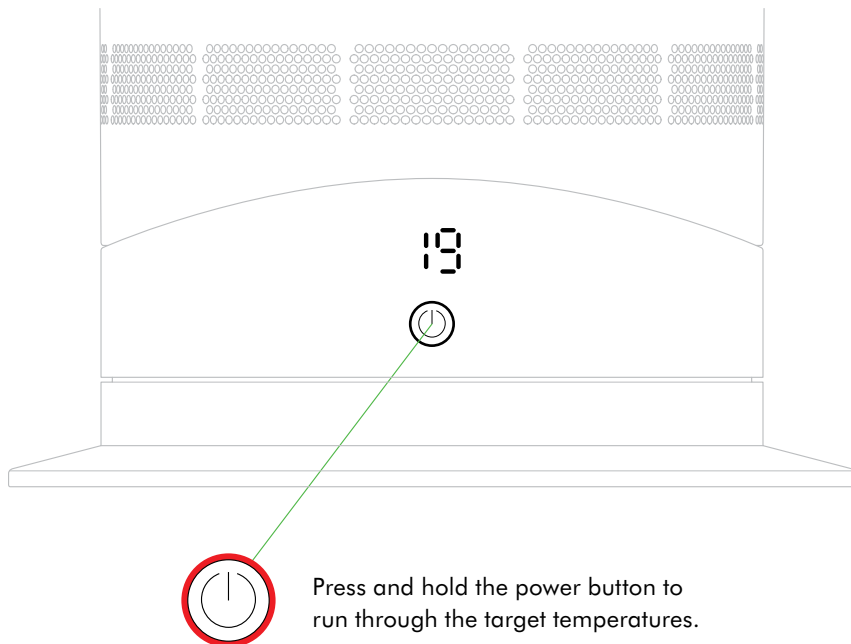

Remote control

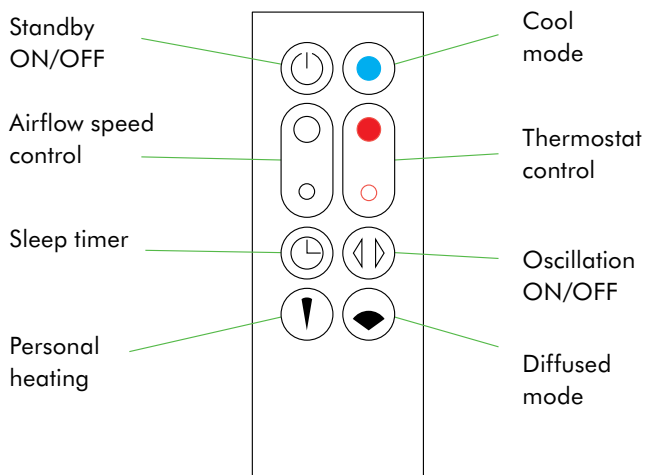

Remote control docks magnetically. Attach the remote control to the top of the appliance with the buttons facing down.

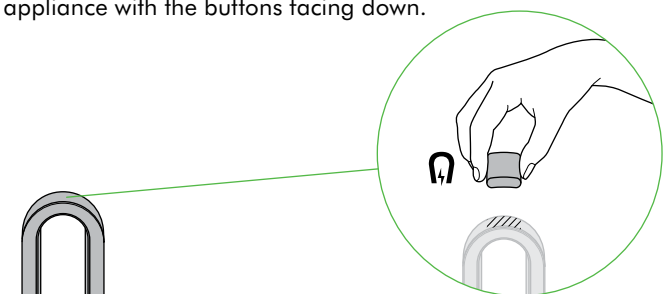

To operate, point the remote control toward the front of the base.

Heating and cool modes

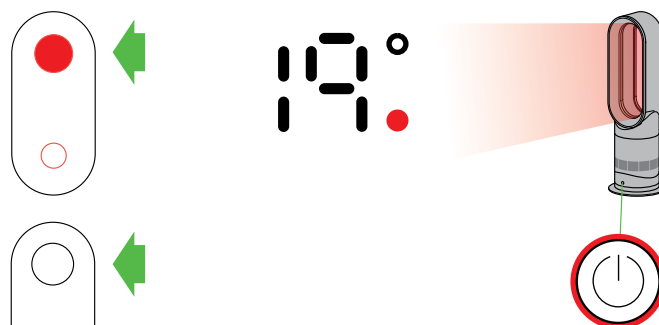

Heating mode

Press the red thermostat control button until the digital display shows the desired target temperature. The power button light will change from blue to red. The red circle will disappear when the target temperature has been reached.



Cool mode

Press the blue thermostat control button to change the target temperature to 0°C. The power button light will change from red to blue. To adjust the airflow speed use the airflow control button.

Sleep timer

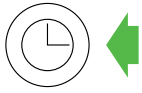

To set the sleep timer, press and hold the timer button to select the desired time. When time reaches zero, the appliance will go into standby mode. To cancel, reduce the time until two dashes appear.

Tilt function

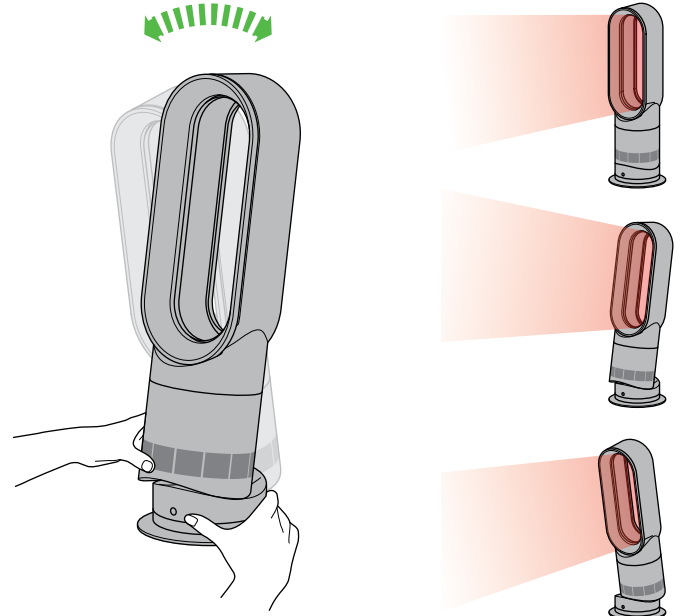

Carefully hold the base and the main body. Tilt the amplifier forward or backward for the required airflow angle.

Diffused and personal heating modes

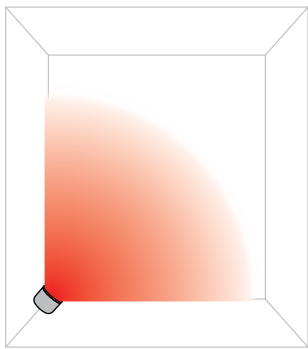

Diffused mode

Press the wide angle button to change from personal heating to whole room heating.

Heating and cool modes work in this mode.

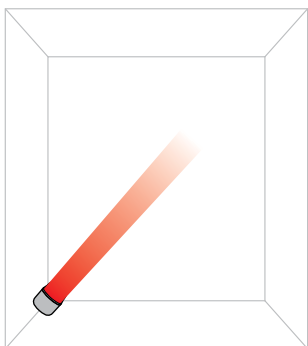
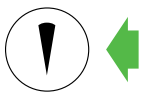

Personal heating

Press the narrow angle button to change from whole room heating to personal heating.

Heating and cool modes work in this mode.

Oscillation and airflow speed control

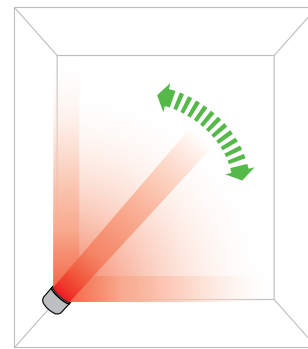
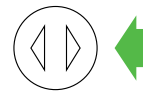

Oscillation control

To start the appliance oscillating, press the oscillation control button. To stop the appliance oscillating, press it again. The appliance will not oscillate when the control buttons are pressed.

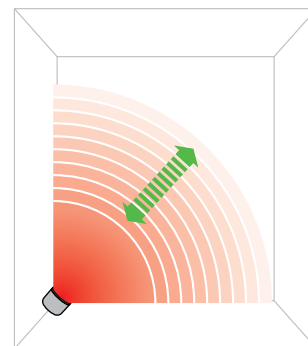
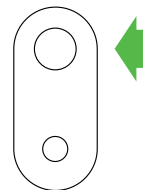

Airflow speed control

To change the airflow speed press the airflow control button. The digital display will show the new speed; after 3 seconds it will change back to the target temperature.

Clearing blockages

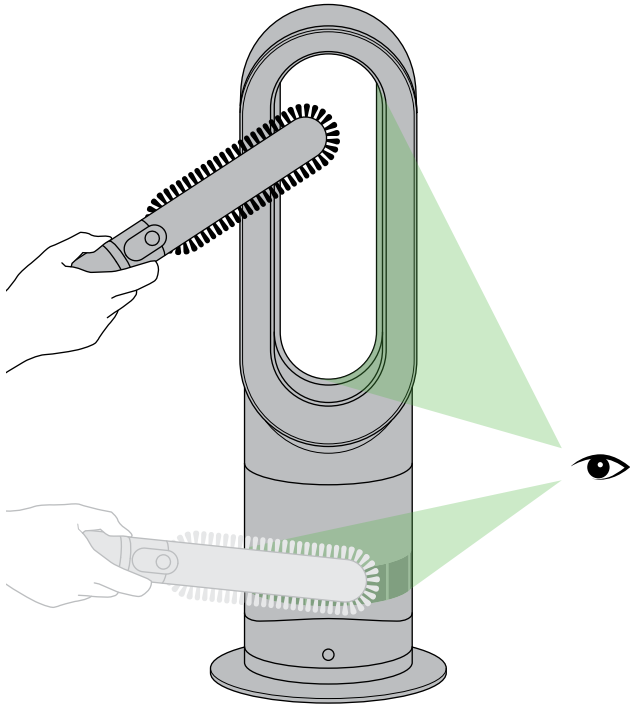

Ensure the appliance is unplugged and has been allowed to cool. Look for blockages in the air inlet holes and in the small aperture inside the air loop amplifier. Use a soft brush to remove debris.

Cleaning

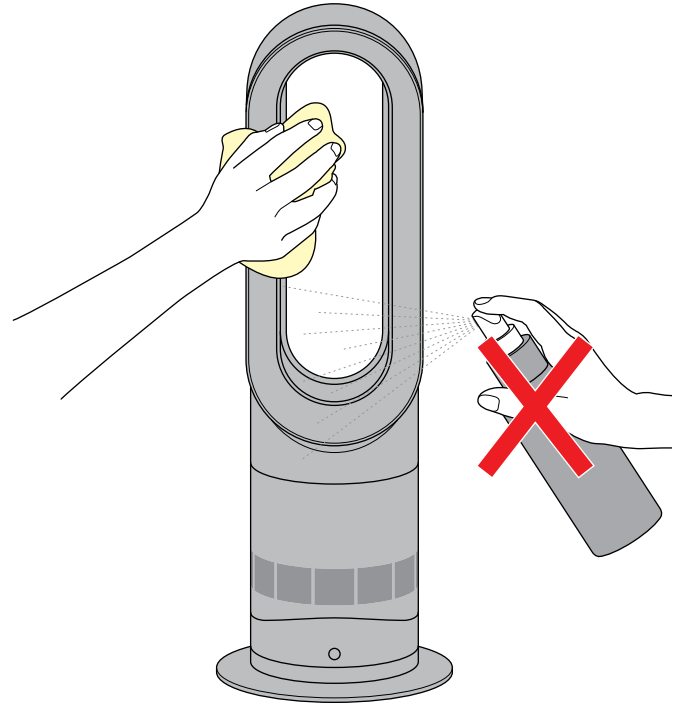

Unplug from the mains electricity supply. Allow to cool for 1 to 2 hours before cleaning if the appliance has been in use. To clean, wipe with a dry or damp cloth. Do not use detergents or polishes.

CAUTION: hot when in use

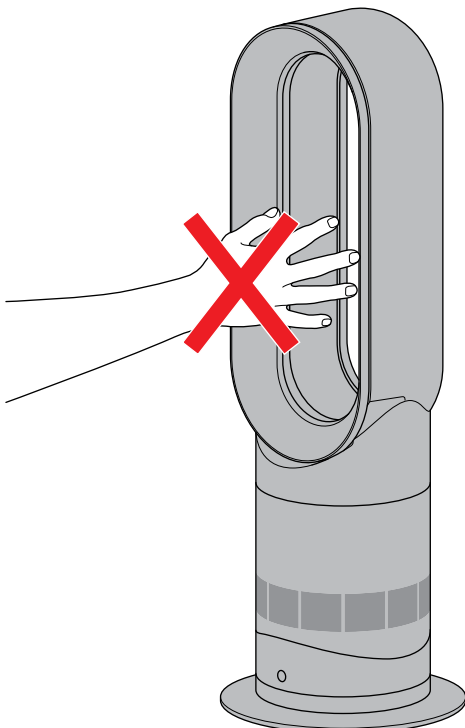

This appliance is hot when in use and for a short period after use. Do not let bare skin touch hot surfaces. If children are present, consider positioning the appliance out of their reach.

Battery replacement

Battery type CR 2032.

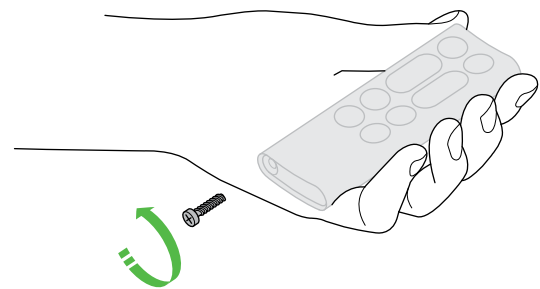

Unscrew the battery compartment on the remote control. Loosen the base and pull to remove the battery.

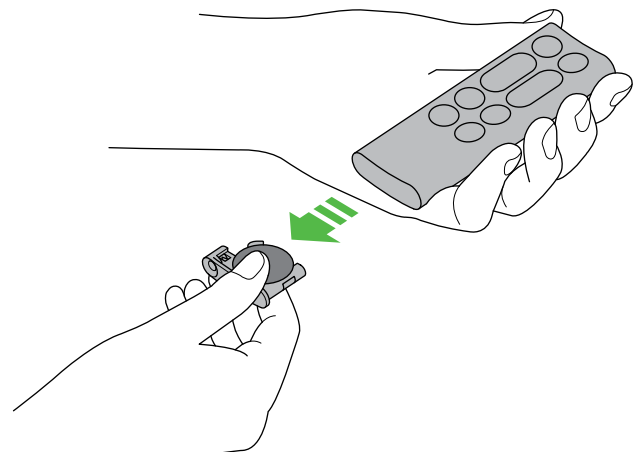

USING YOUR DYSON APPLIANCE

PLEASE READ THE 'IMPORTANT SAFETY INSTRUCTIONS' IN THIS DYSON OPERATING MANUAL BEFORE PROCEEDING.

LOOKING AFTER YOUR DYSON APPLIANCE

- Do not carry out any maintenance or repair work other than that shown in this Dyson Operating Manual, or advised by the Dyson Customer Care Helpline.
- Always disconnect the plug from the mains before inspecting for problems. If the appliance will not operate, first check the mains socket has electricity supply and that the plug is properly inserted into the socket.

OPERATION

- Ensure appliance is fully assembled in line with the instructions before use. Do not dismantle the appliance or use without the loop amplifier fitted.
- The appliance will not operate in heating mode unless the target temperature is above the room temperature.
- Each time the heating mode is selected, it conducts a short calibration cycle. Airflow will be automatically controlled during this cycle. Once the calibration cycle is complete, it will revert to the selected airflow speed.
- The appliance will not oscillate when the control buttons are pressed.
- Do not lubricate any part of this appliance.

CONTROL WITHOUT THE REMOTE

- Press the Standby button on the appliance to turn ON/OFF.
- Press and hold the standby button on the appliance to adjust the target temperature. The target temperature will increase to a maximum before decreasing. If the target temperature is set at 0°C it will switch from heating to cool mode.
- The airflow, diffused and personal heating modes, oscillation function and sleep timer controls cannot be operated without the remote control.

TILT FUNCTION

- Carefully hold the base and the main body. Tilt the amplifier forward or backward for the required airflow angle.

AUTOMATIC CUT-OUT

- For your safety this appliance is fitted with automatic cut-out switches that operate if the appliance tips over or overheats. If the switches operate, unplug the appliance and allow it to cool. Before restarting the appliance check and clear any blockages and ensure the appliance is on a solid level surface.
- In heating mode the appliance will automatically switch 'OFF' after 9 hours of continuous use and will return to standby mode. To restart the machine, press the power button on either the remote control or the base.

TROUBLESHOOTING

- Fault codes F4, F5, F6: If one of these appears on the display, unplug the appliance, wait for 30 to 60 seconds and/or plug the appliance into a different socket. If you continue to receive the fault code, please contact the Dyson Customer Care Helpline.
- Fault codes F2, F3, F7: If one of these appears on the display, please contact the Dyson Customer Care Helpline.

BATTERY REPLACEMENT



CAUTION

- Unscrew the battery compartment on the remote control. Loosen the base and pull to remove the battery.
- Do not install backwards or short circuit the batteries.
- Do not attempt to dismantle or charge the batteries. Keep away from fire.
- Follow battery manufacturers' instructions when installing new batteries (battery type CR 2032).
- Limited functionality is available without the remote control (see 'Control without the remote').

AUSTRALIAN CONSUMER LAW

The details of the Dyson guarantee are set out below. In addition to your rights under the Dyson guarantee, we also provide the following statement as required by the Australian Consumer Law: In Australia, your Dyson appliance comes with statutory guarantees that cannot be excluded under the Australian Consumer Law. You are entitled to a replacement or refund for a major failure and for compensation for any other reasonably foreseeable loss or damage. You are also entitled to have your Dyson appliance repaired or replaced if it fails to be of acceptable quality and the failure does not amount to a major failure.

DYSON 2 YEAR GUARANTEE

TERMS AND CONDITIONS OF YOUR DYSON 2 YEAR GUARANTEE.

- The Dyson guarantee becomes effective from the date of purchase.
- All work will be carried out by Dyson Appliances (Aust) Pty Ltd., Avery Robinson Ltd. (NZ) or their authorised agents.
- Any parts replaced by Dyson or its service agents will become the property of Dyson Appliances (Aust) Pty Ltd. or Avery Robinson Ltd. (NZ).
- The repair or replacement of your Dyson appliance under the Dyson guarantee will not extend the period of the Dyson guarantee.
- The Dyson guarantee provides benefits which are additional to and do not affect your statutory rights as a consumer.
- You must provide proof of (both the original and any subsequent) delivery/purchase before any work can be carried out on your Dyson appliance. Without this proof, any work carried out pursuant to the Dyson guarantee and any associated delivery charges (both to and from us) will be at your cost, subject to your statutory rights and remedies as a consumer. Please keep your receipt or delivery note.

WHAT IS COVERED

Your Dyson guarantee covers:

- The repair or replacement of your Dyson appliance if your Dyson appliance is found to be defective due to faulty materials, workmanship or function within 2 years of purchase or delivery (if any part is no longer available or out of manufacture, Dyson will replace it with a functional replacement part).
- This Dyson guarantee will only be valid if the appliance is used in the country in which it was sold.

WHAT IS NOT COVERED

Under your Dyson guarantee, Dyson shall not be liable for costs of repair or replacement of a product incurred as a result of:

- Accidental damage, faults caused by negligent use or care, misuse, neglect, careless operation or handling of the Dyson appliance which is not in accordance with this Dyson Operating Manual.
- Use of the Dyson appliance for anything other than normal domestic purposes in the country of purchase.
- Use of parts not assembled or installed in accordance with the instructions of Dyson.
- Use of parts and accessories other than those produced or recommended by Dyson.
- Faulty installation (except where installed by Dyson).
- Repairs or alterations carried out by parties other than Dyson or its authorised agents.
- Blockages – please refer to the illustrations and the section 'Clearing blockages' in this Dyson Operating Manual for details of how to look for and clear blockages.
- Normal wear and tear (e.g. fuse etc.).
- If your Dyson guarantee does not apply, you may have statutory rights and remedies available to you as a consumer. If you are in any doubt as to what is covered by your Dyson guarantee, please call the Dyson Customer Care Helpline.

REGISTERING YOUR DYSON GUARANTEE

To help us ensure you receive prompt and efficient service, please register as a Dyson appliance owner. There are three ways to do this:

- Online:
AU: www.dyson.com.au/register
NZ: www.dyson.co.nz/register
- By calling the Dyson Customer Care Helpline.
- By completing and returning the enclosed form to us by mail. This will confirm ownership of your Dyson appliance in the event of an insurance loss, and enable us to contact you if necessary.

ABOUT YOUR PRIVACY

- Dyson may use this information for future marketing and research purposes (including sending commercial electronic messages) and may disclose it to third parties for the purposes of providing the services you have requested or to our business partners or professional advisers.
- If you wish to access your personal information or see our full privacy policy, please contact us at: aucustomercare@dyson.com

DISPOSAL INFORMATION

Dyson products are made from high grade recyclable materials. Please dispose of this product responsibly and recycle where possible. The battery should be removed from the product before disposal. Dispose of or recycle the battery in accordance with local ordinances or regulations.

When your Dyson appliance reaches the end of its life, we are responsible for its safe disposal. You can send your old Dyson appliance back to us (at our cost) and we will organise for it to be recycled. Please note that not all parts are recyclable. Recycling of parts is subject to the capabilities of 3rd party suppliers. Available in Australia only.

Simply:

1. Box up your old Dyson appliance.
2. Take the package to your local post office and send to the address below:

Dyson We Recycle
Reply Paid 83215
Dyson Service Centre
8-10 Mangrove Lane
Taren Point, NSW 2229

PRODUCT INFORMATION

Please note: Small details may vary from those shown.



DYSON CUSTOMER CARE

Your Dyson appliance will be covered for parts and labour for 2 years from the date of purchase, as detailed in the terms of the Dyson guarantee in this Dyson Operating Manual.

If you have a query about your Dyson appliance, call the Dyson Customer Care Helpline quoting your serial number and details of where and when you bought the appliance. Alternatively, contact us via the website.

Most queries can be solved over the phone by one of our Dyson Customer Care Helpline staff.

DYSON CUSTOMER CARE

Australia

Website: www.dyson.com.au

Email: aucustomer@dyson.com

Dyson Customer Care: 1800 239 766 (Mon-Fri 8:00am to 6:00pm EST,

Sat-Sun 8:30am to 4:00pm EST).

Address: Dyson Appliances (Aust) Pty Ltd., PO Box 2835, Taren Point, NSW 2229 Australia.

New Zealand

Website: www.dyson.co.nz

Email: dyson@averyrobinson.co.nz

Dyson Customer Care: 0800 397 667 (Mon-Fri 8:30am to 5:00pm).

Address: Avery Robinson Ltd., Unit F, 151D Marua Road, Ellerslie, Auckland, 1051 New Zealand.

Date of purchase / / Country of purchase Australia New Zealand

Serial number

Title Surname

First name

Address

Postcode

email

Telephone Mobile

Store of purchase

Privacy Act
 Dyson Appliances Ltd (Dyson) may collect and use your personal information to provide you updates on latest products and services, to analyse and research customer's choice on products, to provide products and services you have requested and for other purposes relating or incidental to product guarantee (e.g. product guarantee registration, product recalls) ("the Purposes"). To do so, Dyson may disclose your personal information to its related bodies, business partners or third parties. Some of the recipients are located overseas, including United States of America, Amsterdam and United Kingdom.
 If Dyson does not collect your personal information, then it may not be able to fulfil the Purposes.
 Our privacy policy, located at www.dyson.com.au/support/privacy-policy.aspx, contains information about how you may access and correct your personal information held by Dyson, and the privacy complaints handling process of Dyson.
 You may contact Dyson at aucustomer@dyson.com
 If you wish to receive information and updates about Dyson's products and services, please tick this box.
 Under the Australian Privacy Principles, before Dyson discloses personal information overseas, Dyson will take such steps as are reasonable in the circumstances to ensure that the overseas recipient does not breach the Australian Privacy Principles. However, an individual may consent to such disclosure without this requirement. If you consent to Dyson disclosing your personal information to business partners or third parties overseas for the Purposes, please tick this box.
 Note: If you do not provide consent, then Dyson may not be able to fulfil the Purposes.

3 EASY WAYS TO REGISTER YOUR DYSON 2 YEAR GUARANTEE

REGISTER ONLINE 

Visit our website to register your Dyson full parts and labour guarantee online.

AU: www.dyson.com.au/register
NZ: www.dyson.co.nz/register

REGISTER BY PHONE 

Call our dedicated Helpline.

AU 1800 239 766
NZ 0800 397 667

REGISTER BY MAIL 

Complete and return the form to Dyson in the envelope supplied.

