

Dear Customer,

Thank you for choosing this quality product from ASKO.

We hope it will meet your expectations and fulfil your needs for many years to come. Scandinavian design combines clean lines, everyday functionality and high quality. These are key characteristics of all our products and the reason they are greatly appreciated throughout the world.

To get the most from your new dishwasher, we recommend that you read the operating instructions before using the dishwasher. The operating instructions also include information on how you can help protect the environment.



Operating Instructions

Dishwasher
ASKO D5456

Contents

Front panel	2	Care and cleaning	11
Safety instructions	3	Troubleshooting	13
Before washing for the first time	4	Technical information	16
Loading the dishwasher	4	Installation	18
Using the dishwasher	7	ASKO Service	22
Settings	9	Program chart	23

Front panel

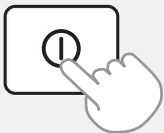

To start the machine, press and hold the main power switch until the display lights up.



- | | | |
|------------------|----------------------------|------------------------------------|
| 1 Daily wash | 7 Child lock (button lock) | 13 Time saver |
| 2 Heavy wash | 8 Rinse aid indicator | 14 Set time (for the Time program) |
| 3 Normal program | 9 Program selector | 15 Start/Stop |
| 4 Eco wash | 10 High temperature | 16 Display |
| 5 Time program | 11 Long dry | |
| 6 Rinse & Hold | 12 Delayed start | |

The panel is fitted with touch buttons with audible feedback (see the chapter Settings).

NOTE!

- Two minutes after the last button press, the display enters left-on mode to save energy. The display brightness is reduced. Press the Program selector once or one of the option buttons to reactivate the display.

Safety instructions

General

- Read the operating instructions and keep them in a safe place!
- Never use the dishwasher for any purpose other than that specified in these operating instructions.
- Do not load the dishwasher door or dishwasher baskets with anything other than dishes.
- Never leave the dishwasher door open as someone may trip on it.
- Use only dishwasher detergent!
- This appliance is not intended for use by persons (including children) with reduced physical, sensory or mental capabilities, or lack of experience and knowledge, unless they have been given supervision or instruction concerning use of the appliance by a person responsible for their safety.
- Damaged mains cables must only be replaced by a qualified electrician.
- This dishwasher is for household or similar use, such as:
 - staff kitchens in shops, offices and other workplaces.
 - farms.
 - for guests at hotels, motels and other types of accommodation.
 - bed & breakfast hotels.
- Never place dishes with solvent residues in the dishwasher due to the risk of explosion. Nor may dishes that contain ash, wax or lubricants be washed in the dishwasher.

WARNING!

Knives and other pointed items must be placed with the points down in the cutlery basket or horizontally in other baskets.

Installation

See the section Installation.

Child safety

- Always close the door and start the program immediately after you have added the detergent.
- Keep children away from the dishwasher when the door is open. Some detergent may remain inside!
- Do not allow children to use or play with the dishwasher. Be especially vigilant when the door is open.

WARNING!

Dishwasher detergents are strongly alkaline. They can be extremely dangerous if swallowed. Avoid contact with skin and eyes and keep children away from the dishwasher when the door is open.

Check that the detergent compartment is empty after completion of the wash cycle.

Activate the child safety lock (Kid Lock™)

(only certain models)

A child safety lock is fitted to prevent children from opening the dishwasher door. To activate the child safety lock, press in the door latch and use a screwdriver to turn the screw slot (top left-hand corner) to a vertical position. To open the door, you must press the white plastic catch (illustrated below) to the left while pressing the door latch up. Reset by turning the screw slot back to a horizontal position.

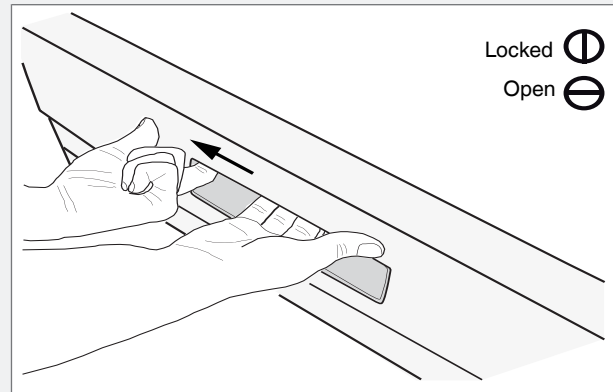

Activate child lock (Kid Safe™)

You can activate the child lock (button lock) to prevent children from starting the dishwasher (see the section Settings).

Winter storage/Transport

- Store the dishwasher where the temperature remains above freezing.
- Avoid long transport distances in very cold weather.
- Transport the dishwasher upright or laying on its back.

Overflow guard function

The overflow protection starts pumping out the machine and turns off the water supply if the water level in the dishwasher exceeds the normal level. If the overflow protection is triggered, turn off the water supply and call the service department.

Cleaning

When cleaning the edge around the door, use only a slightly damp cloth. Do not spray water around the edge! Moisture can make its way into the lock, which contains electrical components.

Packing material

Sort waste materials in accordance with local guidelines.

Disposal

- When the dishwasher has reached the end of its service life and is to be disposed of, it should immediately be made unusable. Pull out the power cable and cut it as short as possible.
- The dishwasher is manufactured and labelled for recycling.
- Contact your local authority for information about where and how your dishwasher should be correctly recycled.

Before washing for the first time

Checking water hardness

Contact the local water utility to check the water hardness in your area. This is important with regard to how much detergent and rinse aid to use.

Top up with rinse aid

By using rinse aid you will improve your drying result. You will also achieve a better dishwashing result with glassware and dishes.

- 1 Open the rinse aid compartment lid.
- 2 Carefully top up with rinse aid. Only add rinse aid to the level marked **max**.
- 3 Wipe up any splashes of rinse aid around the compartment.
- 4 Close the lid firmly.

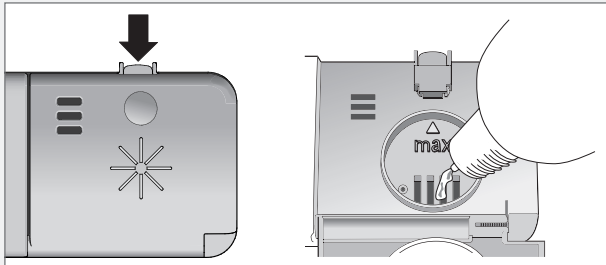

Refill rinse aid indicator

When the rinse aid needs topping up, the above symbol lights on the display.

NOTE!

After topping up, it may take a while before the symbol goes out.

Setting the rinse aid dosage

The section Settings describes how to set the rinse aid dosage. Rinse aid dispensing can be set from **S: 0** (Off) to **S: 6** (High dose). (Factory settings: **S: 5**)

Increase the rinse aid dosage:

- If the dishes have water marks.

Decrease the rinse aid dosage:

- If the dishes have a sticky white/blue film.
- If the dishes are streaked.
- Build-up of foam. If you have very soft water, the rinse aid can be diluted 50:50 with water.

For water with a hardness greater than 10–12 °dH, you ought to use rinse aid with citric acid (known as acid rinse aid).

Loading the dishwasher

Economic dishwashing

Run programs only with a full load

Wait to run a program until the dishwasher is full. This way you save energy. Use the Rinse & Hold program to rinse the dishes if there are any unpleasant odours while you wait for the dishwasher to become fully loaded.

Run programs at a lower temperature

If the dishes are only slightly dirty, you can select a lower temperature with certain programs. See also the section Selecting Options in the chapter Using the dishwasher.

Select a program with the option Short dry

To save energy, use Short dry. The drying result will be better if, once the program is finished, you leave the door slightly open.

Do not rinse under running water

Simply scrape off large food particles before loading the dishwasher.

Choose a green detergent

Read the environmental declaration on the packaging!

Connect to cold water...

If you use oil or electricity to heat your home.

Connect to hot water (max. 70 °C)...

If you use district heating, solar power or geothermal power to heat your home. Choosing a hot water connection cuts program times and reduces the dishwasher's electricity consumption.

Fragile dishes

Some cookware is not dishwasher safe. This can be for several reasons. Some materials cannot withstand strong heat, others can be damaged by dishwashing detergent.

Fragile decoration

Porcelain with decoration on top of the glazing (the items feel rough) should not be washed in a dishwasher.

Crystal/Glass

Place items so that they do not touch each other during the wash. Use a short program with the lowest possible wash temperature. Select Short dry. Delicate and very fragile items should not be washed in a dishwasher.

Glassware washed in a dishwasher at high temperatures can gradually develop a grey film that cannot be removed. Wash fine glassware at a low temperature and with a small amount of detergent.

Silver

Silver and stainless steel items should not come into contact, as the silver can become discoloured.

Cutlery with glued handles

Some types of glue are not dishwasher safe. In such cases, the handles may loosen.

Wood

Wooden items should only be washed in a dishwasher if marked dishwasher safe.

Aluminium

Aluminium can lose its shine if washed in a dishwasher. However, good quality aluminium pans can be washed in a dishwasher, even if some of the shine will be lost.

Plastic items

Avoid washing plastic items that cannot withstand high temperatures.

The dishwasher's baskets

The dishwasher is equipped with a top cutlery tray, an upper basket and a lower basket with cutlery basket.

The appearance of the baskets may differ depending on the dishwasher setup.

Top cutlery tray

The top cutlery tray has space for cutlery, ladles, whisks, serving cutlery and similar items.

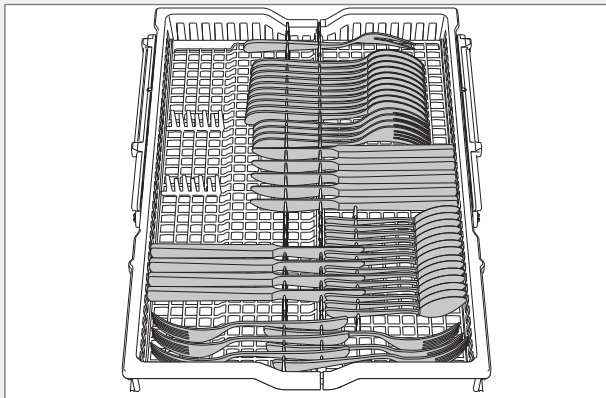

Raising the top cutlery tray

- 1 Pull out the top cutlery tray.
- 2 Pull the two locking handles on either side forward to raise the top cutlery tray.

Lowering the top cutlery tray

- 1 Pull out the top cutlery tray.
- 2 Slide the two locking handles on either side downwards and backwards to lower the top cutlery tray.

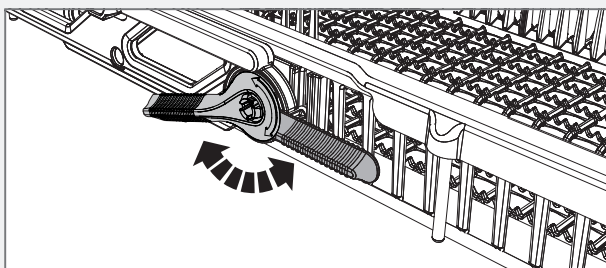

Upper basket

Place glasses, cups, bowls, side plates and saucers in the upper basket. All dirty surfaces should face inwards and downwards! Wine glasses are placed on the wine glass shelf and knives are placed in the knife stand on the right (if fitted).

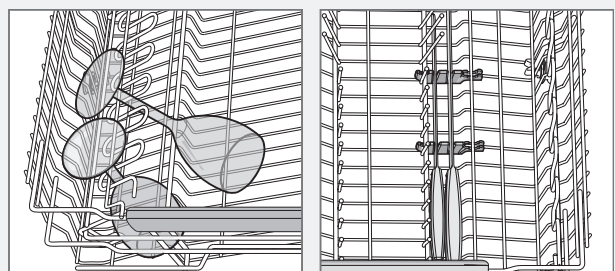
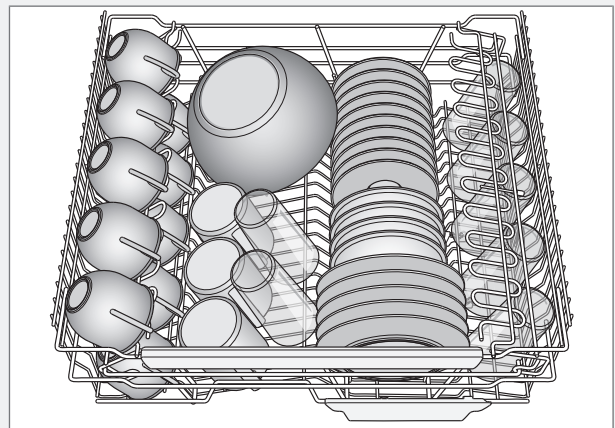

Lower basket

Place plates, side plates, serving dishes, pots and cutlery (in the cutlery basket) in the lower basket.

Place pots and pans in the rear right part of the lower basket to achieve the best dishwashing results from the rear of the two spray nozzles (WideSpray™), which are intended for these types of dishes.

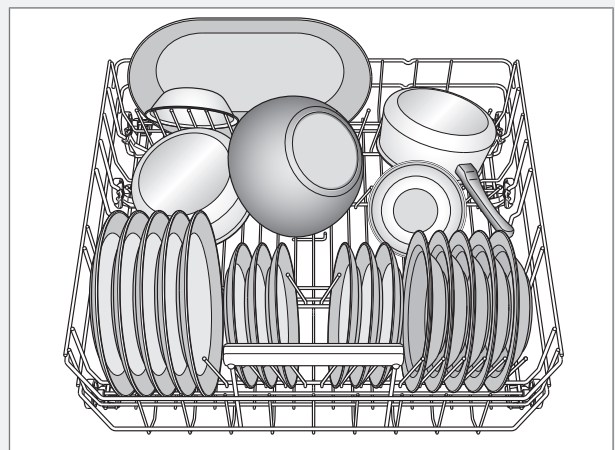

Foldable tines

Lower the foldable tines (plate supports) when washing pots and pans. Release the foldable tines by pressing the catch inwards before adjusting their position.

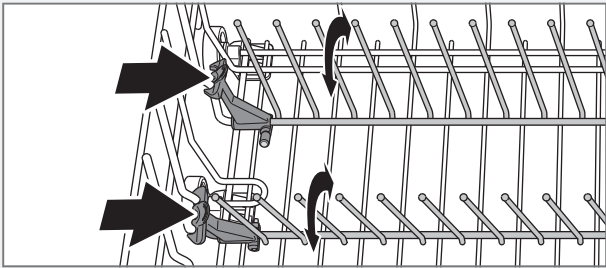

Washing large plates

Move the foldable tines and their mounts to widen the distance between the tine rows to adapt the lower basket to plates with a diameter greater than 25 cm.

Cutlery basket

Place cutlery with the handles facing down, except for knives, and spread them out as much as possible. Ensure that spoons do not stack inside each other.

The cutlery basket is best placed in the middle at the front of the lower basket to best utilise dishwashing performance from the unique spray nozzle (Power Zone Cutlery™), which is intended for the cutlery basket.

! WARNING!

Knives and other pointed items must be placed with the points down in the cutlery basket or horizontally in other baskets.

Fold-down section for small items

The cutlery basket has a fold-down section in the middle for small items, or small shafts, such as electric whisk attachments.

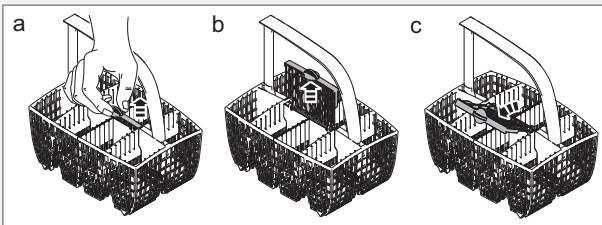

Cutlery basket with lid

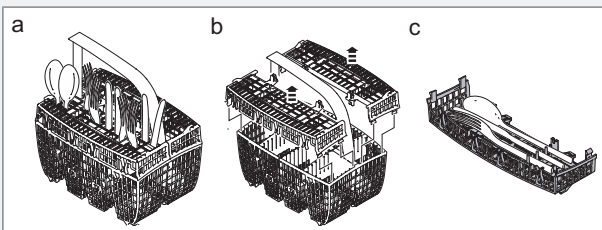

Positioning of cutlery basket lid (in upper basket)

The cutlery basket lid can be removed and used, for example, as an extra cutlery basket in the upper basket (see below).

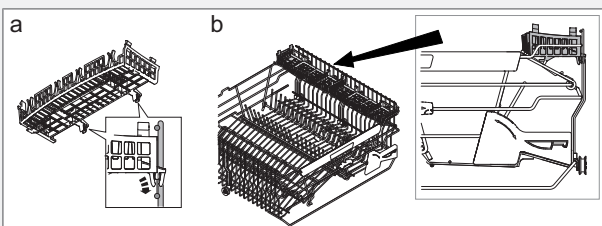

NOTE!

Check that the spray arms can rotate freely.

Using the dishwasher

Add detergent

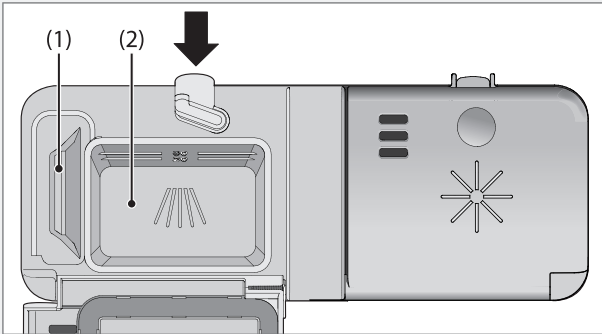

- 1 Prewash detergent compartment
- 2 Main wash detergent compartment

Detergent is added according to water hardness.

Follow the instructions on the detergent packaging.

Too much detergent can result in less effective dishwashing and also entails greater environmental impact.

Add the detergent to the detergent compartment. There is a compartment for the prewash and one for the main wash. If powder and liquid dishwasher detergents are used, add a small amount of the detergent to the prewash compartment. Contact the detergent manufacturer if you have any questions about the detergent.

⚠ WARNING!

Children must be supervised – dishwasher detergent is corrosive!

NOTE!

Use only dishwasher detergent! Washing up liquid must not be used as the foam that forms prevents the dishwasher from operating effectively.

Dishwasher tablets

Halve the tablet if it is difficult to close the dispenser lid. There is a risk that the detergent will not be released properly if the lid is tight and will not open correctly.

NOTE!

Dishwasher tablets are not recommended for short programs (less than 75 minutes). Use powder or liquid dishwasher detergent instead.

3-in-1/All-in-one detergent

Read through the directions for these products carefully. If anything is unclear, contact the detergent manufacturer.

ⓘ Main power switch

Press the main power switch and close the door.

Program selection

Press the Program selector one or more times until the desired program symbol lights.



Daily wash

A program suitable for day-to-day dishwashing. This program can also clean dried leftovers, but is not intended for burnt food, such as on oven dishes.



Heavy wash

Program for very dirty dishes, such as pans, casserole dishes and oven dishes. If these dishes do not completely fill the dishwasher, you can add plates and the like.



Normal program

Use to wash normally soiled load, such as plates, serving dishes, cups, glasses and so on.

For washing normally soiled mixed loads, with the best energy and water performance, use the **Normal program**; low temperature, short drying (no options).

If you want to improve the dishwashing and drying result activate the options **high temperature** ⚡ and **long drying** ☁. This causes a slight increase in energy consumption.

Eco Eco wash

Use when you want to save water. For normally dirty dishes.



Time program

The program adapts to the specified running time or finish time. With this program it is important to choose a time suited to how dirty the dishes are.

0:30-1:15 Slightly dirty dishes

1:30-2:00 Normally dirty dishes

2:15-3:00 Very dirty dishes

To set the program time, see the section Selecting Options.



Rinse & Hold

Used to rinse dishes while you wait for the dishwasher to become fully loaded.

Selecting Options

To select an option, press one of the option buttons. The indicator lamp for a button lights when the option is activated. The available options depend on the selected program. Once you have started the program, the options you selected are saved for the next time you use the same program. An exception is the Delayed start option.





High temperature

Activate this option for improved dishwashing results. The machine then uses a higher temperature for the main wash. This option cannot be activated if the Time saver option is selected.

If you want to use the lower temperature, press so that the indicator lamp turns off.

You can vary the temperature as shown below:

 Heavy wash: 60 °C / 70 °C

 Normal program: 48 °C / 65 °C

 Daily wash: 60 °C / 65 °C

Eco Eco wash: 53 °C / 60 °C

Long dry

The higher temperature in the final rinse and longer drying improves the drying result if you activate the Long dry option. This causes a slight increase in energy consumption. This option can be used with all programs except Time program. This option cannot be activated if the Time saver option is selected.

If you want a program with Short dry, press so that the indicator lamp turns off.

Delayed start

When you select Delayed start, the dishwasher will start 1–24 hours after you press the Start/Stop button.

- 1 Press the button once to activate Delayed start. Press the button several times – or hold it in – to set the desired number of hours.
- 2 Press Start/Stop and the dishwasher counts down 1 hour at a time and starts after the selected delay.

Press and hold Start/Stop for five seconds if you want to cancel the Delayed start option.

NOTE!

Remember to press the Start/Stop button to start the program.

Time saver

This option shortens the program time, but uses more energy and water. This option can be selected with Daily wash, Heavy wash or Normal program.

Set Set time

Press the option button several times – or hold it in – to set the desired program time for Time program. You can choose a program time between 30 minutes and 3 hours.

Start the dishwasher

Press and hold Start/Stop until the display flashes three times with the remaining time. This indicates that the program has started. Close the door properly, otherwise the dishwasher will not start. The display indicates  if the door is open.

NOTE!

If the machine does not start within 2 minutes of the last button press, the display returns to showing the last program run.

Time remaining

Once you have selected a program and options, the display indicates how long the program took the last time it was used. Once you have started the dishwasher, the display indicates how much program time remains. The remaining time is updated after the water for the final rinse has been heated.

This may differ somewhat from time to time depending on the temperature of the water supply, the amount of dishes, the ambient temperature and other factors.

While the program is running, the time counts down and the remaining program time is shown on the display. The remaining time is shown, for example, as 1:15, which means the program will run for another 1 hour and 15 minutes.

NOTE!

During the first run of each program, the remaining time displayed can be slightly misleading, as the dishwasher is estimating the time. When you run the program a second time, the dishwasher will calculate the remaining time based on the previous duration of the program.

Stopping or changing a program

In order not to accidentally press a button and cancel the current program, you must press and hold Start/Stop for five seconds if you want to change programs after starting the dishwasher. Add more detergent if the lid of the detergent dispenser has opened. Then choose a new program and press Start/Stop.

Do you want to add more dishes?

Open the door. The dishwasher stops automatically. Add the dishes, close the door and the dishwasher continues the program.

If the dishwasher is turned off using the main power switch or due to a power failure

If the dishwashing program was not finished, the interrupted program continues when power is restored.

NOTE!

During drying, the program is interrupted if the power is cut or the door is open for more than 2 minutes.

Once the program has finished

Once the program has finished, “End” appears on the display.

At the end of the program, you will hear a short beep. Chapter Settings describes how to change this function.



Once the dishwasher has finished, it only uses standby power. Turn off the dishwasher with the main power switch if you want to cut the power completely. Shut off the water tap after every use.

Drying

For additional drying the door should be opened 35 mm upon completion of the drying cycle. For more information, see page 16 in the chapter Technical information.

Settings

Do as follows to open the settings menu:







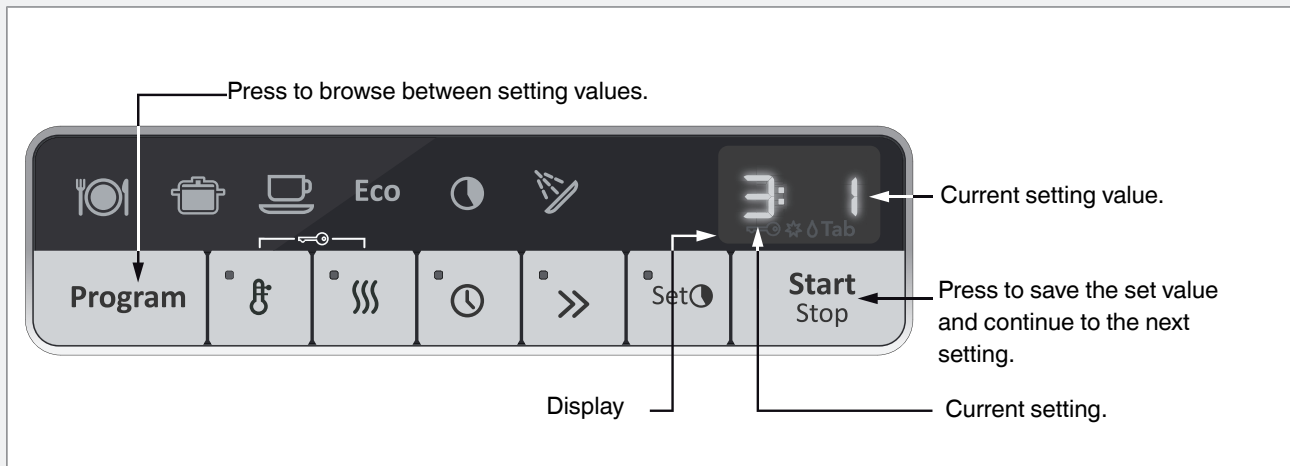



	Button press	Description
1.		Turn off the dishwasher using the main power switch. Wait about five seconds. Then press the main power switch again. Wait until the numbers appear in the right-hand display before continuing to the next step.
2.	Program + 	Within five seconds, press and hold the Program selector (wait for the audible signal confirming the button press) and then immediately press the Long dry button without releasing the Program selector.
		Keep the buttons pressed until the symbols for the Daily wash and Rinse & Hold programs start to flash.

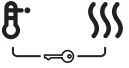





TIP!

Be sure to press right on the symbols, so as not to inadvertently activate any other button. Try again if you fail to open the settings menu the first time.



You can now adjust the following settings:

Button press	Options	Settings	Description
	<ul style="list-style-type: none">  (Off)  (On) 	Child lock (Kid Safe™)	<p>You can activate the child lock (button lock) option to prevent children from starting the dishwasher.</p> <p>Press the High temperature and Long dry buttons simultaneously to temporarily deactivate the button lock when you want to start the dishwasher. The button lock is automatically reactivated after 2 minutes.</p> 
	<p>Press Start/Stop to save the setting value and continue to the next setting.</p> <p>If you do not want to change any other settings, keep pressing Start/Stop to step through the entire settings menu.</p>		
	<ul style="list-style-type: none">  (Off)  (Low)    (High) 	Buzzer volume	The dishwasher uses a buzzer to indicate when a program is finished or when a fault has occurred.

Button press	Options	Settings	Description
Start/Stop 	Press Start/Stop to save the setting value and continue to the next setting.		
Program 	3: 0 (Off) 3: 1 (Low) 3: 2 3: 3 3: 4 (High)	Operation volume	This sound is used to confirm each button press.
Start/Stop 	Press Start/Stop to save the setting value and continue to the next setting.		
Program 	4:- 1 (Low) 4: 0 4: 1 4: 2 4: 3 (High)	LCD contrast	For adjusting the contrast of the display.
Start/Stop 	Press Start/Stop to save the setting value and continue to the next setting.		
Program 	5: 0 (Off) 5: 1 (Low dosage) 5: 2 5: 3 5: 4 5: 5 5: 6 (High dosage)	Rinse aid	Rinse aid dosage setting.
Start/Stop 	Press Start/Stop to exit the settings menu.		

Care and cleaning

Coarse filter

The coarse filter traps larger food particles, which cannot get past the drainage pump. Empty the coarse filter as necessary.

- 1 Lift the coarse filter by the handle.
- 2 Empty the coarse filter. Remember to replace it!

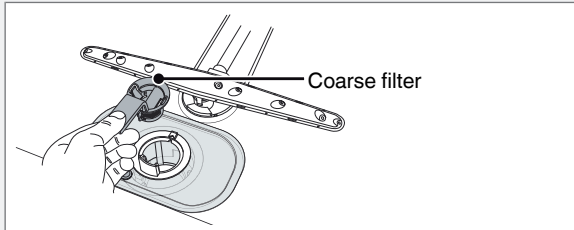

Fine filter

Debris that collects on the fine filter is automatically rinsed away during each wash. However, the fine filter and its pipe section should be cleaned a couple of times a year.

- 1 Turn the handle anticlockwise once.

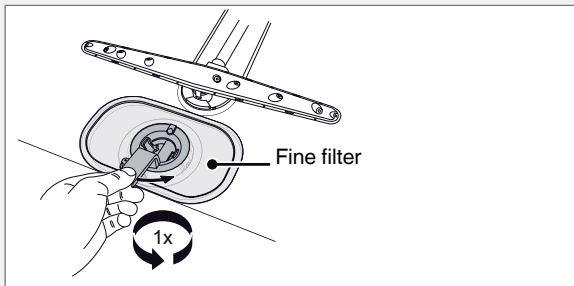

- 2 Lift the pipe section straight up by the handle. Free the coarse filter to clean the pipe section.
- 3 Remove and clean the fine filter.
- 4 Replace in reverse order. Check that the edges seal properly when replacing the fine filter.

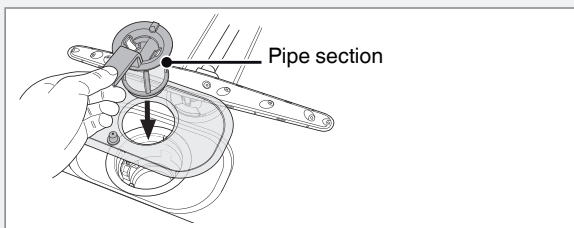

- 5 Lock the filter in place by turning the handle clockwise to the stop position. The handle should point straight out from the dishwasher.

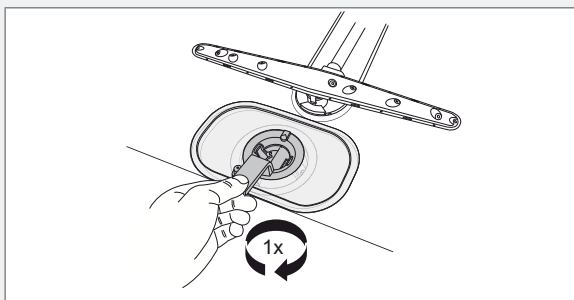

NOTE!

The dishwasher must not be used without the filter in place!

Diswashing efficiency can be affected if the course filter is incorrectly fitted. After cleaning ensure that filter handle is fully locked with the handle pointing out of the dishwasher.

Drainage pump

The pump can be accessed from inside the dishwasher.

- 1 Cut the power to the dishwasher by pulling out the plug from the wall socket!
- 2 Remove the coarse filter and pipe section.
- 3 Remove the small yellow fitted piece at the left of the bottom drain (see illustration below).

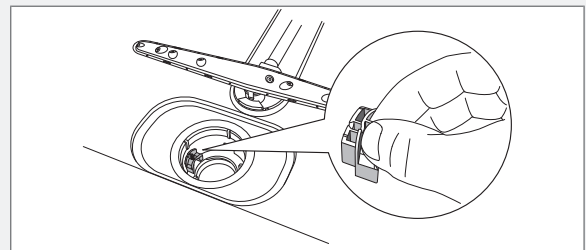

- 4 By inserting your finger into the hole you can turn the pump blade to release anything blocking it.

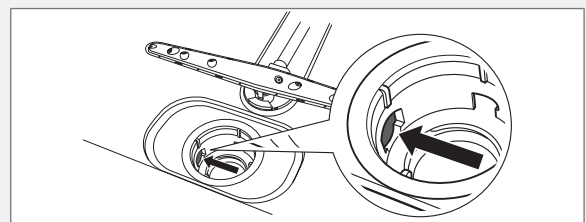

- 5 Reinstall the fitted piece and filters.
 - 6 Plug the machine in again.
- If the dishwasher still does not start and a whirring sound is heard, the overflow protection has been activated.
- Shut off the water.
 - Remove the plug from the wall socket.
 - Call the service department.

NOTE!

Do not forget to reinstall the fitted piece.

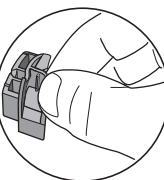

Spray arms

Holes and bearings can sometimes become blocked. Remove any debris using a pin or something similar. The spray arms also have holes on their undersides.

To facilitate cleaning, you can remove the spray arms. Remember to screw them firmly back into place afterwards.

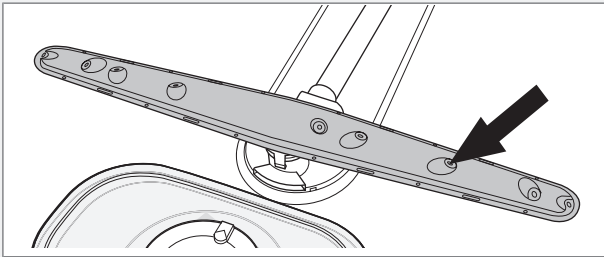

Lower spray arm

- Pull the lower spray arm straight up to release it.

Upper spray arm

- The upper basket must be removed before the upper spray arm can be released. Pull out the upper basket and turn the basket catch on each runner outwards (see illustration). The basket can now be removed.

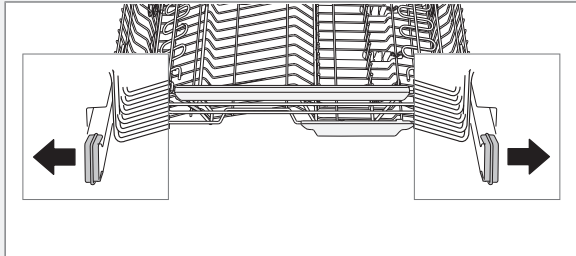

- Pull the upper spray arm straight up to release it.

Top spray arm

- The upper basket must be removed before the top spray arm can be released. See section Upper spray arm.
- Pull out the top cutlery tray. Press the top spray arm up and unscrew the spray arm bearings counter-clockwise to remove the spray arm.

Door

When cleaning the edge around the door, use only a slightly damp cloth (with a little cleaner if necessary).

! WARNING!

Do not use a spray bottle or the like around the door lock. This is to ensure that water does not penetrate the door catch and come into contact with the electrical components.

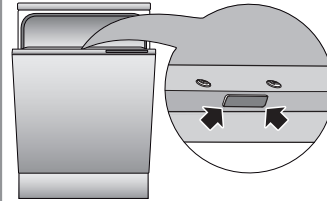

Limescale deposits

The dishwasher tub is made of stainless steel and is kept clean through normal use. However, if you have hard water, limescale deposits may form in the dishwasher. If this happens, run the Normal program program with high temperature and two table-spoons of citric acid in the detergent compartment (with no dishes in the machine).

Front panel

Keep the touch buttons clean and free from grease. Wipe them clean with a dry or slightly damp cloth. Never use cleaners – they can scratch the surface. Use the main power switch to turn off the dishwasher before cleaning the touch buttons to avoid activating any buttons unintentionally.



Troubleshooting

Display	Type of fault	Action
F: 10	Overfilling ¹⁾	Call the service department.
F: 11	Water outlet fault ¹⁾	See "Water remains in the dishwasher" in the table below.
F: 12	Water inlet fault ¹⁾	Check that the water tap is on. Check whether dishwasher inlet hose is connected to a pressure limiting valve (some pressure limiting valves may restrict the supply of water to the dishwasher).
F:40	Inlet valve leakage ¹⁾	Turn off the water tap and call the service department.

¹⁾ Turn off the machine with the main power switch and then turn it on again to clear the error message from the display.

Problem	Possible causes	Action
The dishes are not clean.	The spray arms do not rotate.	Remove the arms and clean them. Check that the dishes are not blocking the spray arms.
	Old detergent. Detergent is a perishable product.	Avoid large packages.
	Incorrect detergent dosage.	Dose according to water hardness. Far too much or far too little detergent results in poorer dishwashing results.
	Dishwashing program too weak.	Select a higher temperature or a more powerful program.
	Dishes loaded incorrectly.	Do not cover porcelain with large bowls or the like. Avoid placing very tall glasses in the corners of the baskets.
	Glasses and cups have toppled over during the program.	Place dishes to sit steady.
	The filter is not correctly fitted.	Screw the filter firmly into place. See the section Care and cleaning.
Spots or films on the dishes.	Incorrect rinse aid dosage setting.	See the sections Before washing for the first time and Settings.
	Too high temperature and/or too much detergent can cause etching on crystal. Unfortunately, this cannot be repaired, only prevented.	Wash crystal at a low temperature and with a conservative amount of detergent. Contact the detergent manufacturer.
The dishes have a sticky white/blue film.	Rinse aid dosage setting too high.	Reduce the amount. See the sections Before washing for the first time and Settings. If you have very soft water, you may want to dilute the rinse aid 50:50 with water.
Spots on stainless steel or silver.	Some foodstuffs, such as mustard, mayonnaise, lemon, vinegar, salt and dressings, can mark stainless steel if left for too long.	Rinse off these types of foodstuffs if not starting the dishwasher immediately. Why not use the Rinse & Hold program.
	All stainless steel can cause spots on silver if they come into contact during dishwashing. Aluminium can also cause spots on dishes.	Silver and stainless steel items should not come into contact during dishwashing.
Spots left after washing.	Lipstick and tea can be difficult to wash off.	Use a detergent with a bleaching agent.

Problem	Possible causes	Action
Rattling sound when dishwashing.	The dishes are not correctly placed or the spray arms are not rotating.	Check that the dishes are placed securely. Spin the spray arms to make sure they can rotate.
The dishwasher does not start.	The Start/Stop start button has not been pressed for long enough.	Press and hold Start/Stop until the display flashes three times with the remaining time.
	The door is not properly closed.	Check.
	A fuse/circuit breaker has been tripped.	Check.
	The plug is not plugged into the wall socket.	Check.
	The water tap is turned off.	Check.
	Overflow/leaks	Check.
	A whirring sound (the drainage pump) is heard from the dishwasher and does not stop when the main power switch is turned off.	Turn off the water tap. Pull out the plug and call the service department.
1 minute appears in the display.	Check that the Delayed start option has not been selected.	Press and hold Start/Stop for five seconds if you want to cancel the Delayed start option.
	The program is taking longer than estimated.	None, next time the program is run the corrected time will be displayed.
Water remains in the dishwasher.	Blocked drainage hose.	Loosen the drainage hose where it connects to the sink unit's water trap. Check that no debris has fastened. Is the cone-shaped part of the pipe cut to an inner diameter of at least 14 mm?
	Kink in drainage hose.	Check that the hose is free from kinks and sharp bends.
	The filters are blocked.	Clean the coarse and fine filters.
	The filter is not locked in completely.	Ensure filter is completely locked with handle pointing towards the door.
	Debris in the drainage pump.	Clean the drainage pump. See the section Care and cleaning.
Bad odour in dishwasher.	Dirt around the seals and in corners.	Clean with washing-up brush and low foaming cleaner.
	Low temperature programs have been selected for a prolonged period.	Run a program with a higher temperature about once a month.
The dishes are not dry enough.	Drying power too low.	Activate the Long dry option.
	The dishwasher is not fully loaded.	Fully load the dishwasher.
	Rinse aid needs topping up or dosage is set too low.	Top up with rinse aid or increase the rinse aid dosage. See the sections Before washing for the first time and Settings.
		Open the door a little once the program has finished.
Cannot close door.	The baskets are not correctly positioned.	Check that the baskets are correctly positioned horizontally.
		Check that the dishes are not blocking the baskets from sliding properly into place.

Problem	Possible causes	Action
The touch buttons do not react when pressed.	You have pressed the touch buttons too soon after opening the door.	Wait a moment then try again.
	Dirt on the touch buttons.	Clean with a dry or slightly damp cloth.
	Child lock (button lock) activated.	See the section Settings.

Technical information

Information for test institute

Energy labelling

Australian standard: AS/NZS 2007
 Number of place settings: 14
 Dishwashing programs: Normal program; Low temperature, Short dry (no options)
 The door should be opened upon completion of the drying cycle a distance of 35 mm at V.

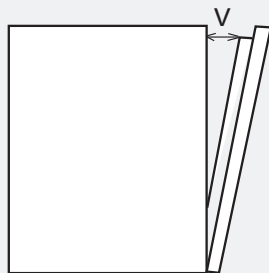

Program time: 2:20 hours:minutes
 Connection: Cold water 20 °C
 Test method for noise measurement: IEC 60704-2-3

Dosages during testing

Detergent: In accordance with AS/NZS 2007
 Prewash: 7.5 gram
 Main wash: 25 gram
 Rinse aid: In accordance with AS/NZS 2007
 Rinse aid dosage: 5

Loading the dishwasher

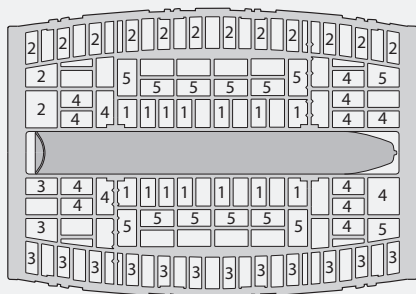
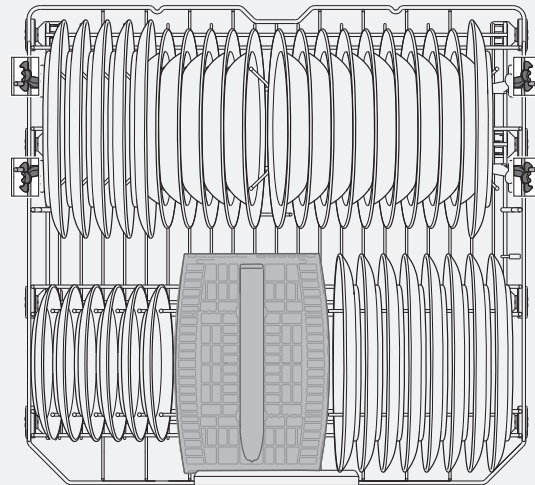
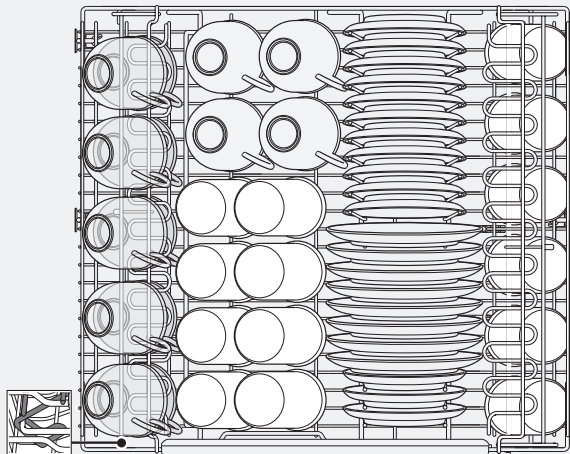

- 1 Teaspoons
- 2 Dessertspoons
- 3 Soup spoons
- 4 Forks
- 5 Knives

Remove the top cutlery tray.

Technical data

Height:	817-872 mm
Width:	596 mm
Depth:	559 mm
Weight:	49 kg ¹⁾
Capacity:	14 Place settings ²⁾
Water pressure:	0.03–1.0 MPa 0.3–10 kp/cm ² 3–100 N/cm ²
Electrical connection:	See compliance plate
Rated power:	See compliance plate

¹⁾ *Weight can vary due to different specifications.*

²⁾ *In accordance with standard, AS/NZS 2007.*

Installation

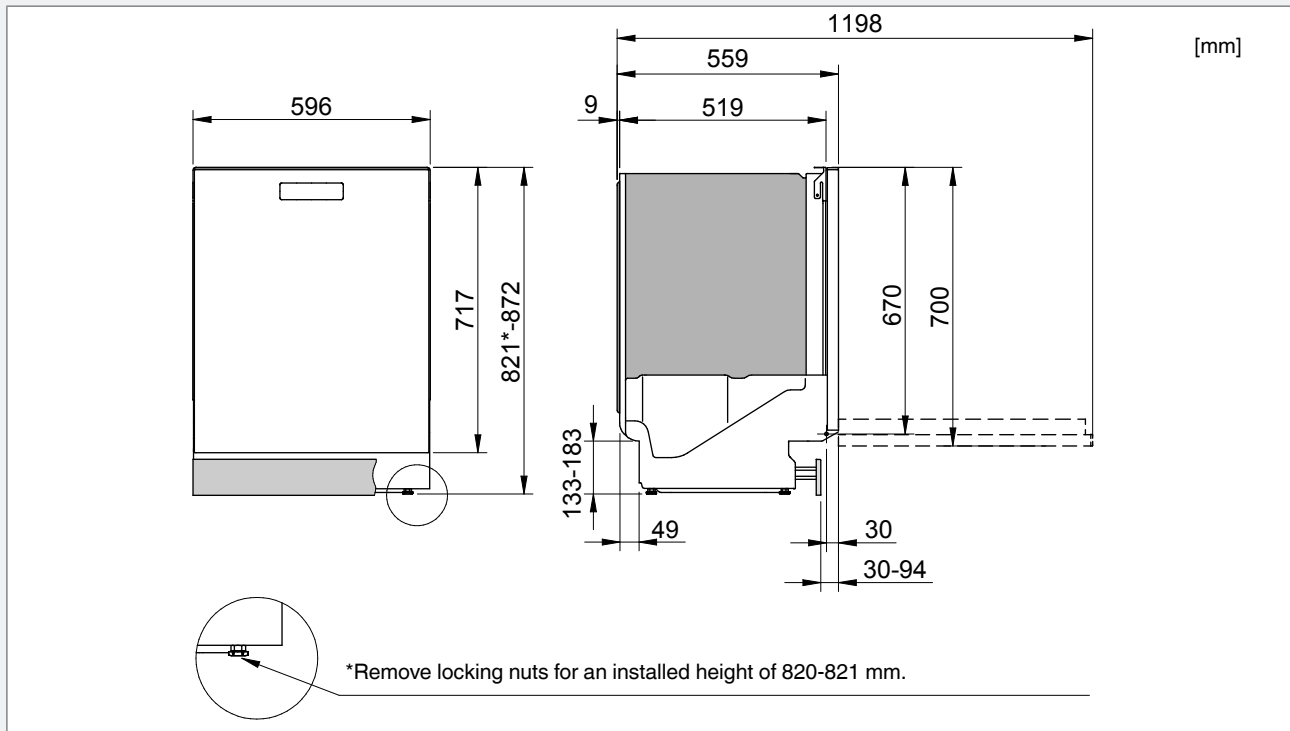

Safety instructions

- Connections to electricity, water and drainage must be performed by a qualified professional.
- Always follow applicable regulations for water, drainage and electricity.
- Take care during installation! Wear protective gloves! There must always be two people!
- Before screwing the dishwasher into place, test the dishwasher by running the Rinse & Hold program. Check that the dishwasher fills with water and drains. Check also that none of the connections leak.

WARNING!

Turn off the water supply when installing the dishwasher!

WARNING!

The plug must be disconnected or power to the socket turned off while the work is carried out!

Transport protection for the door

Do not forget to remove the transport protection for the door when unpacking the dishwasher.

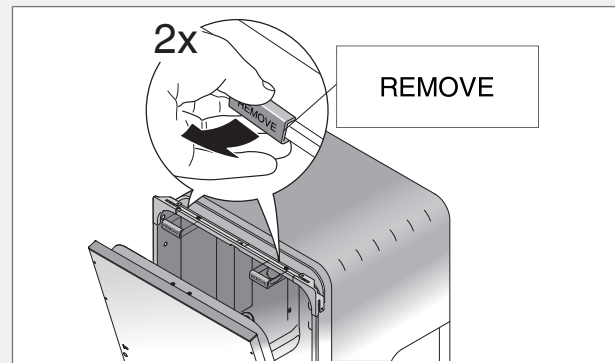

Suggested machine installations

The dishwasher can be installed built-in, completely freestanding or partially built-in.

A. Built-in

The dishwasher is intended for installation under a worktop. The recess dimensions are illustrated. Holes for wires/cables need not be larger than 38 mm in diameter. Make sure the edges of such holes are even to prevent damage to the drainage and inlet hoses and the power cable.

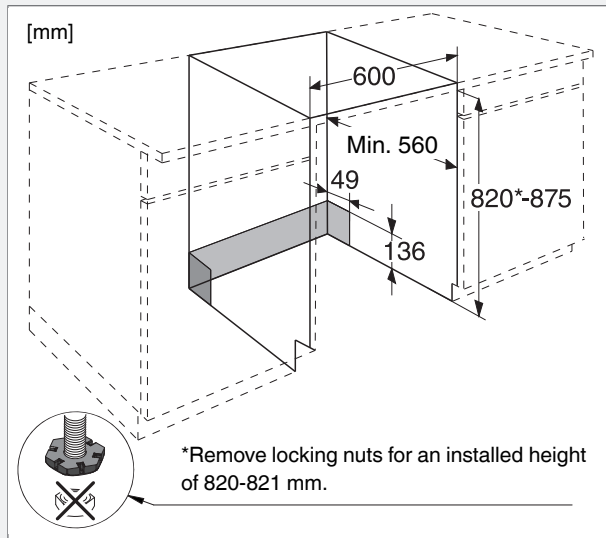

B. Freestanding

A freestanding dishwasher must be fitted with anti-tip brackets. This comprises two brackets, which are screwed into place as illustrated.

The dishwasher is then pushed in so that the brackets engage the rear feet. Now the dishwasher will not topple if pressure is put on the open door. If the dishwasher is installed completely on its own, side panels and a worktop must both be fitted. Accessories can be purchased where you bought the dishwasher.

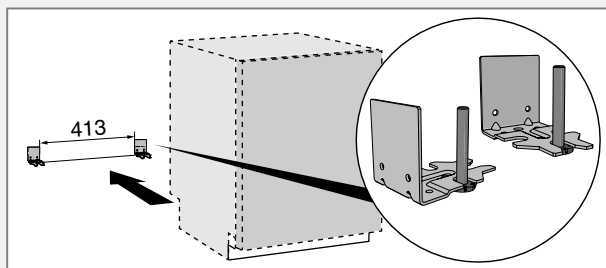

! WARNING!

A completely freestanding dishwasher must be fitted with anti-tip brackets.

C. Partially built-in

If the dishwasher is located so that one of its sides is visible, a side panel must be fitted. Accessories can be purchased where you bought the dishwasher.

Adjust the height and slide the dishwasher into place

- 1 Start by measuring the height from the floor to the bottom edge of the worktop.
- 2 Measure the height from the floor to the top edge of the dishwasher.
- 3 Adjust all feet by turning them clockwise to raise or anticlockwise to lower the dishwasher.

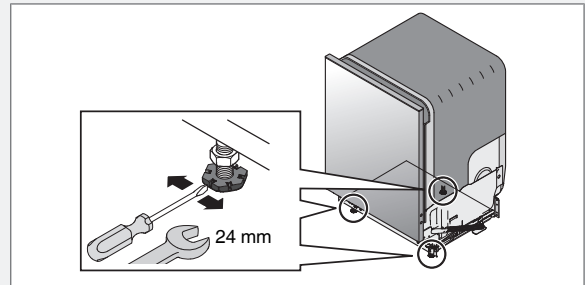

- 4 Check that there is an air gap of at least 3 mm between the underside of the worktop and the top edge of the dishwasher.
- 5 Tighten the lock nuts (lock nut) on the rear feet.
- 6 Slide the dishwasher into place.
 - Pull through the drainage and supply hoses when the machine is slid into place.
 - Check that the hoses have no kinks or sharp bends, and check that there is nothing that can damage the hoses.

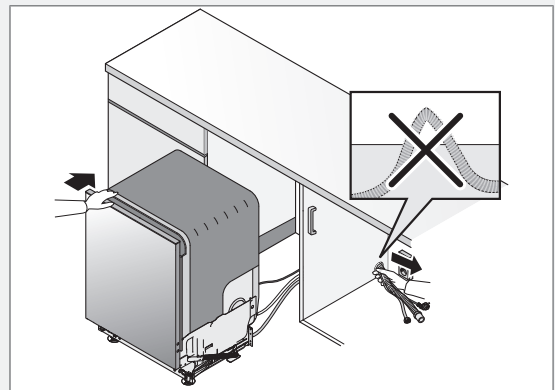

- 7 Make any final adjustments to the front feet (the dishwasher may lean no more than 5 mm) and tighten the lock nuts.

If you want to install your dishwasher freestanding, skip steps 1, 2 and 4 above.

Drainage connection

When the drainage hose is routed to a connection nipple on the sink unit's water trap (see illustration 1), please note that the hose must be attached at the same height as the underside of the sink unit, otherwise dishwasher water from the sink may flow back into the dishwasher. The drainage hose is threaded onto the cone-shaped connection pipe on the sink unit's water trap. The cone-shaped pipe must be cut to an internal diameter of at least 14 mm. For other connection alternatives, see illustrations 2 and 3.

The drainage hose may be extended by a maximum of 3 m (the total length of the drainage hose must not exceed 4.5 m). Any joins and connecting pipes must have an internal diameter of at least 14 mm. However, the drainage hose should ideally be replaced with a new hose without joins.

No part of the drainage hose may be more than 950 mm above the bottom of the dishwasher. The hose must not be routed directly to a floor drain or the like. In such cases, the hose can act as a siphon and empty the dishwasher.

The hose must always discharge at least 350 mm above the bottom of the machine.

Ensure that the drainage hose has no kinks.

NOTE!

The hose must be attached at the same height as the underside of the sink.

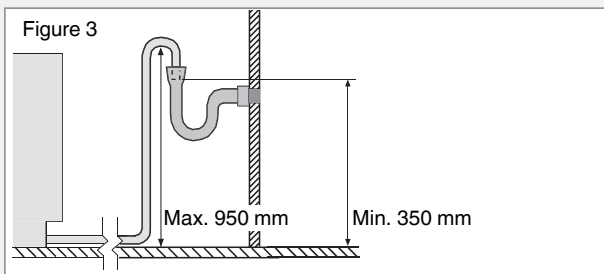
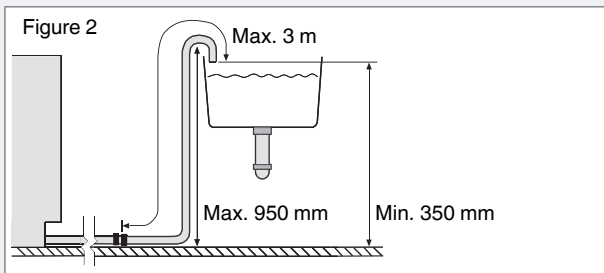
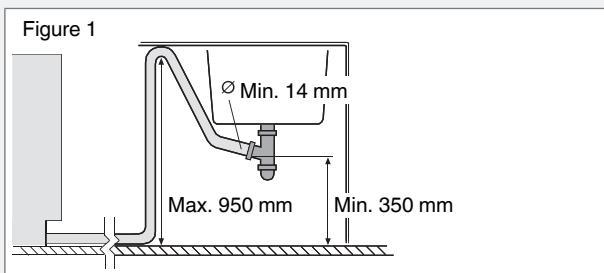

Connection to water supply

Use only the supply hose provided with the dishwasher. Do not re-use old hoses or other spare supply hoses.

The supply pipe must be fitted with a stopcock. The stopcock must be easily accessible, so that the water can be shut off if the dishwasher has to be moved.

Once the installation is complete, the stopcock should be opened to allow the pressure to settle for a while and to check that all connections are tight.

Connect to cold water...

If you use oil or electricity to heat your home.

Connect to hot water (max. 70 °C)...

If you use district heating, solar power or geothermal power to heat your home. Choosing a hot water connection cuts program times and reduces the dishwasher's electricity consumption.

NOTE!

Connecting a dishwasher to the water supply via certain types of pressure limiting valves may restrict the water supply!

This may cause **F:12** error code/ Water inlet fault to be displayed.

Electrical connection

Information about the electrical connection can be found on the compliance plate. This specification must match the electricity supply.

Dishwashers fitted with a plug must be connected to an earthed socket.

The electric wall socket must be placed outside of the installation area to be easily accessible after installing the dishwasher. Do not use an extension cord!

NOTE!

Repairs and maintenance must be carried out by a qualified professional.

Screwing the dishwasher into place

(Applicable only to built-in dishwashers.)

After fastening the machine, check that the front feet still touch the floor.

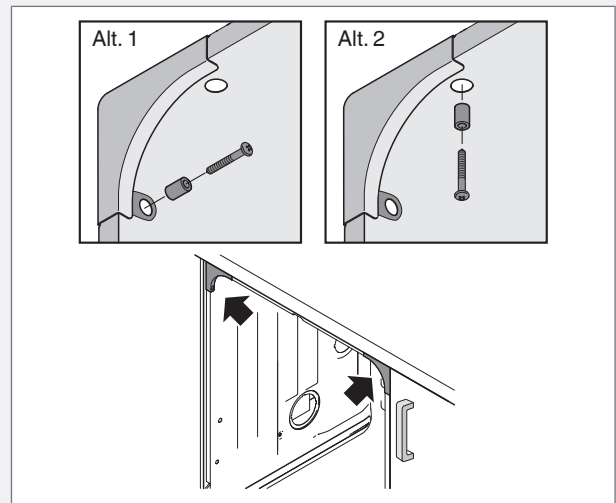

Adjusting the plinth (only when using toe kick accessory)

The dishwasher is supplied with one or two toe kicks depending on the model. The table shows which toe kick you should use depending on the recess height and plinth depth.

Recess height (mm)	Plinth depth (mm)								
	30	40	50	60	70	80	90	100	
820	N/A	N/A	N/A	N/A	N/A	L	L	L	
830	N/A	N/A	N/A	N/A	L	L	L	L	
840	L	L	L	L	L	L	L	L	
850	N/A	N/A	N/A	N/A	N/A	H	H	H	
860	N/A	N/A	N/A	N/A	H	H	H	H	
870	H	H	H	H	H	H	H	H	

L Low toe kick □ 700456 ■ 700457 ■ 702602
(height=90 mm)

H High toe kick □ 700440 ■ 700441 ■ 702603
(height=120 mm)

N/A Not recommended for aesthetic reasons.

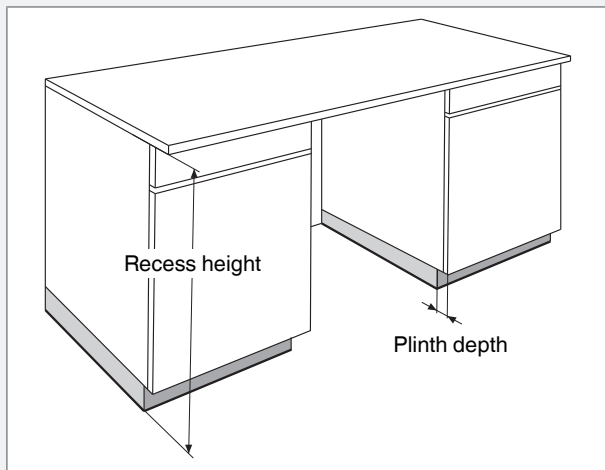

Set the correct plinth depth as follows

* (Not applicable to all models)

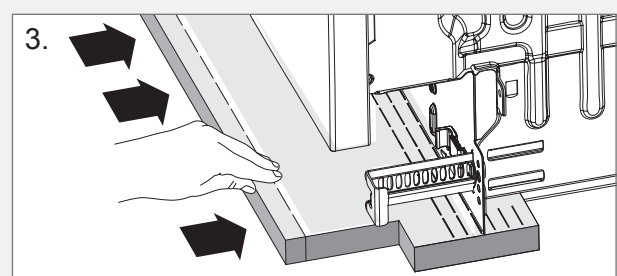
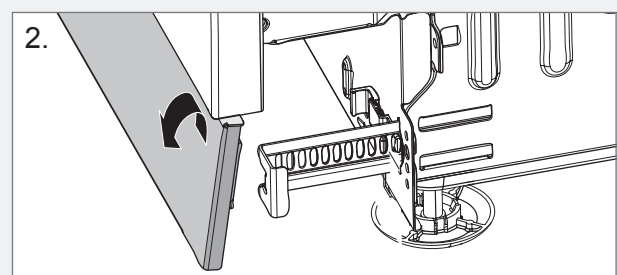
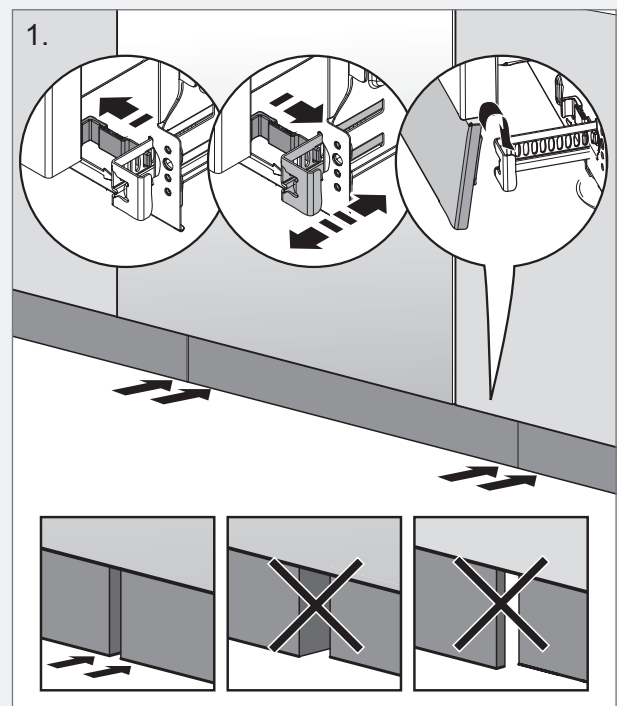
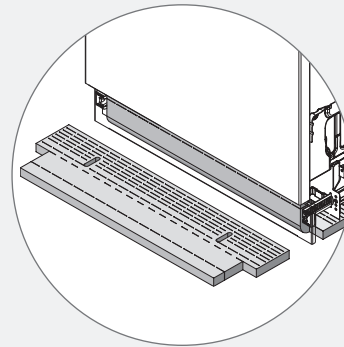

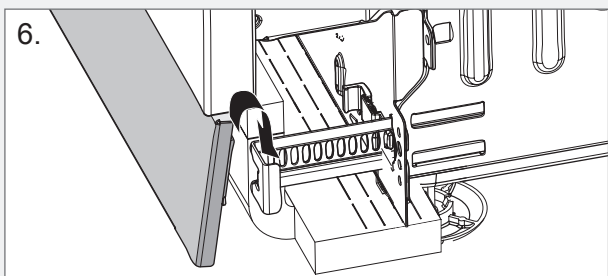
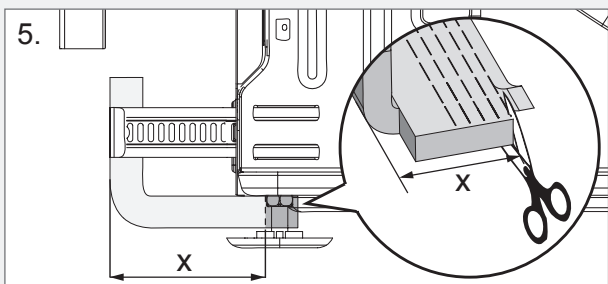
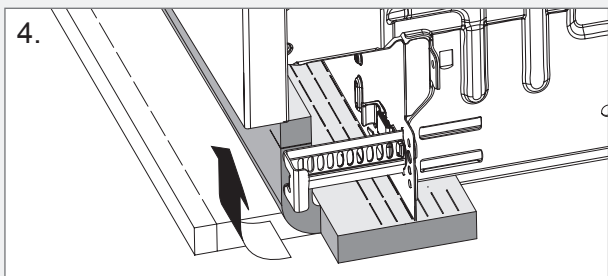

Information about your product



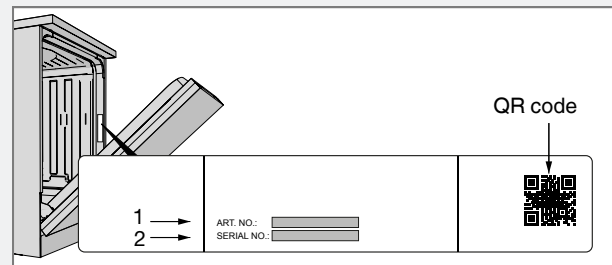

There is a QR code on the compliance plate. Scan the code to view information about your product.

Contact the service department

Read the chapter Troubleshooting before contacting the service department. Provide the details on the compliance plate in all contact. Include the item number (1) and the serial number (2).



Program chart

Program	Options	Prewashes	Main wash (°C)	Number of rinses	Final rinse temperature (°C)	Consumption values ¹⁾						
						Cold water ²⁾			Hot water ³⁾			Water consumption (liter)
						Dishwashing time (approx. hrs:min)	Energy (approx. kWh)	Dishwashing time (approx. hrs:min)	Energy (approx. kWh)			
 Daily wash		1	60 °C	2	65 °C	2:25	1.3	2:10	0.7	13		
 Heavy wash		2	60 °C	2	60 °C	3:15	1.5	3:00	1.0	19		
 Normal program ⁴⁾		2	48 °C	2	45 °C	2:20	0.73	2:05	0.4	12.7		
Eco Eco wash			55 °C	2	50 °C	2:30	0.8	2:15	0.5	11		
 Time program		0-2	max. 65 °C	2-3	max. 65 °C	0:15-2:30	0.5-1.6	0:15-2:30	0.4-1.2	11-19		
 Rinse & Hold				1	--- °C	0:06	0.01	0:06	0.01	3		

1) Consumption values vary depending on the temperature of the incoming water, room temperature, load size, selected options, etc.

2) Connection to cold water, approx. 20 °C.

3) Connection to hot water, approx. 60 °C.

4) The energy label performance figures are based on this program which is recommended for normally soiled load (no options).

Quick guide

1.

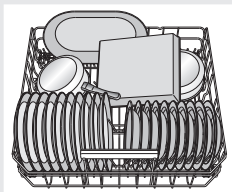

Load the baskets

(See page 4.)

Do not rinse dishes under running water before loading them in the dishwasher. Simply scrape off large food particles before loading the dishwasher.

2.

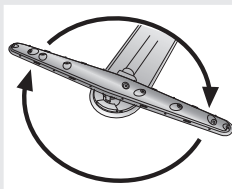

Check that the spray arms can rotate freely

Check also that the water tap is on.

3.

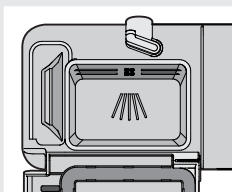

Add detergent

The detergent compartment has one smaller compartment for the prewash and one for the main wash. (See page 7.)

4.

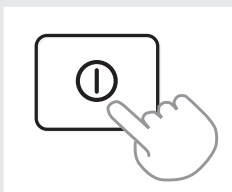

Press the main power switch and close the door

5.



Check/Add rinse aid

Use rinse aid to achieve good washing and drying results. (See page 4.)

☾ Refill rinse aid indicator.

6.

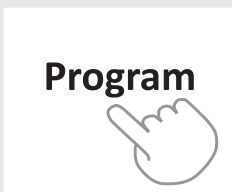

Select a program and any options

(See page 7.)

7.



Press Start/Stop

 **ASKO**



en (03-16)